



SEALING AND BONDING
IN FACADES
THE COMPETENCE
COMPENDIUM

BUILDING TRUST





CONTENTS

04 INTRODUCTION

06 FACADE TECHNOLOGIES

08 STRUCTURAL GLAZING

- 10 FACADE SYSTEM COMPONENTS – GLASS AND METAL FRAME
 - 11 Sikasil® SILICONE SEALANTS IN DETAIL
 - 12 ONE-COMPONENT VS. TWO-COMPONENT SILICONES
 - 13 MECHANICAL PROPERTIES
 - 14 BEHAVIOR AND RESISTANCE
 - 16 Sikasil® SG SILICONE ADHESIVES
 - 18 JOINT DESIGN
 - 19 CALCULATING JOINT BITE
 - 20 CALCULATING JOINT THICKNESS
 - 22 ULTIMATE SAVINGS BY STRENGTH
Sikasil® SG-550, Sikasil® IG-25 HM Plus
-

24 INSULATING GLAZING

- 26 Sikasil® IG SECONDARY SEALANTS
 - 27 Sikasil® IG-25 HM Plus – ENERGY-SAVING WITH INERT GAS FILLING
 - 28 SEAL HEIGHT CALCULATION
 - 29 EFFECT OF ENVIRONMENTAL LOADS
-

30 WEATHERSEALING

- 30 Sikasil® WS WEATHERSEALS
 - 32 NATURAL STONE SEALING
 - 34 FIRE-RATED SEALING
-

37 PRETREATMENT AGENTS

38 VALUE ADDED PRODUCTS

- 38 SikaMembran® SYSTEM – PERFECT VAPOR PROOFING IN ALL CLIMATES
 - 40 SikaTack® Panel SYSTEM – RAIN SCREEN CLADDING
 - 42 SikaDamp® – NOISE REDUCTION IN PANEL WALLS
 - 44 SikaForce® GG GLASS GROUT – STRESS FREE GLASS EMBEDDING
-

46 SIKA BONDING EXCELLENCE

- 48 SYSTEMATIC PROJECT WORKFLOW
 - 48 PROJECT TESTS
 - 49 TRIPLE-TESTED PRODUCT QUALITY
 - 50 SUPPORT BEYOND STANDARDS
-

52 Sikasil® PRODUCTS IN DETAIL

INTRODUCTION

High-tech solutions for perfect facades

ARCHITECTURE THRIVES ON CHANGE. On creative ideas and bold solutions that fascinate and surprise us every time. Curtain walls (CW) are a particularly severe challenge for planners, because they not only set the character of the structure, but must also meet stringent requirements.

CREATIVE FACADE ARCHITECTURE

To strike the ideal balance between aesthetic appeal and energy efficiency, architects are increasingly turning to glass for curtain wall construction. As transparent structural glazing walls, single, double or triple glazed or even double skin facades. Glass can also be combined with other materials such as natural stone, metals or plastic coated metals, giving planners a wide scope for creativity.

But an immaculate optical appearance isn't the only crucial factor. Facades and windows must provide long-term durable systems. This requires perfect adhesion between the components and highly elastic, weatherproof seals. These specifications call for high-tech silicone sealants, which are tailored to meet highly specific demands and guarantee peak performance in every respect. With this application in mind, Sika supplies a wide range of tried-and-tested, innovative facade products for every demand:

- Sikasil®. Each of these sealants and adhesives has highly specific properties that are precisely tailored to the particular application. From structural glazing and insulating glass secondary seals through to weatherseals.
- SikaMembran® membrane systems supplement ideally the sealants range for water/ vapor proofing wide joints in both curtain wall and ventilated facades, see page 38.
- SikaTack®-Panel. Various adhesives and accessories for elegant and durable bonding of facade panels to a sub-structure (Rain Screen Cladding), see page 40.
- SikaDamp®. Self-adhering sound damping sheets for an efficient noise reduction on metal panels and profiles, see page 42.
- Sikagard®. Sprayable sound damping coating for an efficient noise reduction on metal panels and profiles, see page 42.
- The self-leveling polyurethane grout SikaForce® GG is an easy-to-apply product for stress-free embedding of glass balustrades and glass walls in fin glazing, see Page 44.

FUNCTIONS OF A STRUCTURAL GLAZING FACADE

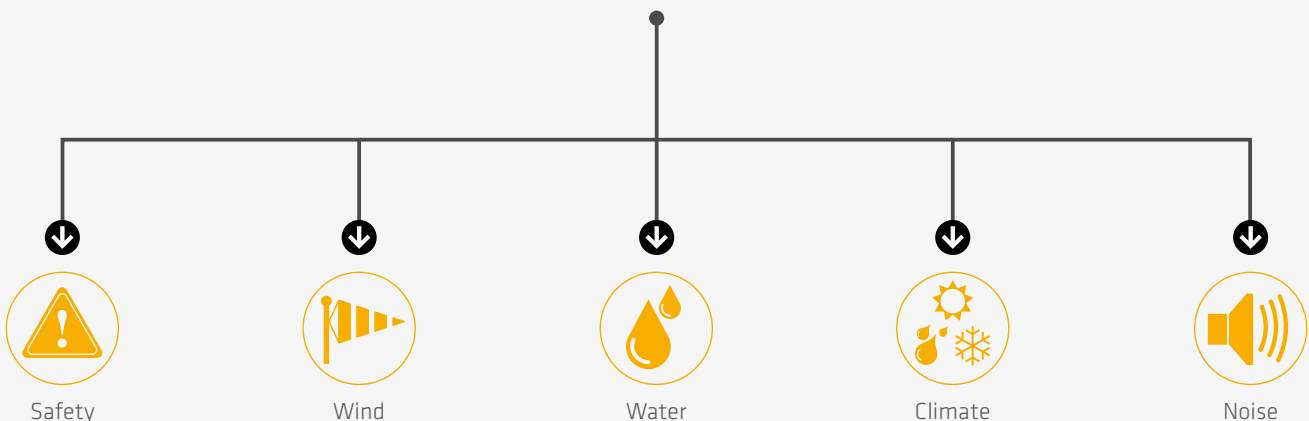

CREATIVE DESIGN, CHALLENGING LOADS, INNOVATIVE MATERIALS

Sika has the right solutions

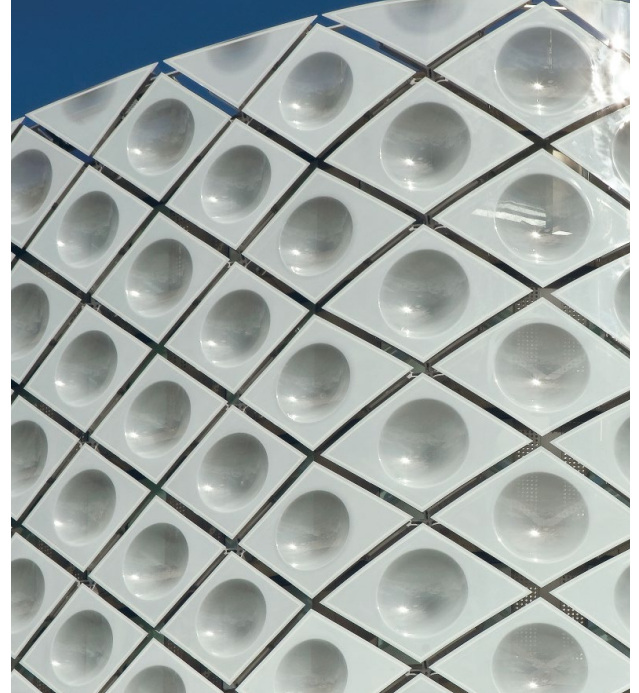

top right:
Hospital Rey Juan Carlos, Madrid, 2012
Architects Rafael De La-Hoz
Facade Permasteelisa Spain
Curved Glass Cricursa

bottom right:
National Swimming Center (Water Cube), Beijing, 2008
Architects State Construction Engineering Corp., PTW Architects
Facade Shenyang YuanDa

left:
Lakhta Tower, St. Petersburg, 2019
Architects Gorprojects
Facade Josef Gartner (DE)
Special challenge: Cold-bent Insulating Glass

FACADE TECHNOLOGIES

Durable solutions for every design

STRUCTURAL GLAZING SYSTEMS can be either two- or four-sided, with each design having its own particular advantages. In general, for efficient and energy-saving building management, double and triple glazing is recommended.

1 Optimum Transparency

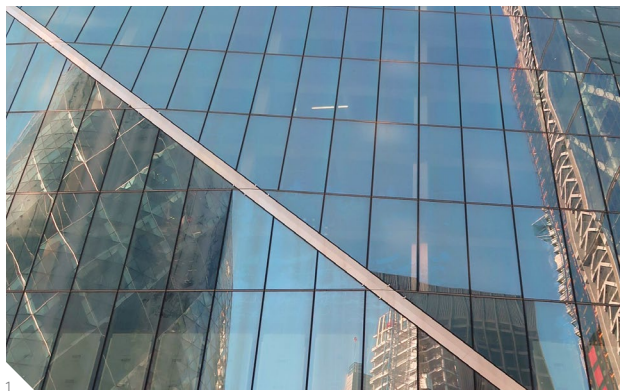

FOUR-SIDED STRUCTURAL GLAZING

Frameless Appearance

Four-sided structural glazing is impressive first and foremost because of its monolithic frameless appearance. All four sides of the large-format pane element are bonded to an adapter profile with Sikasil® SG silicone adhesive sealants and have no visible frame. These prefabricated glass modules are subsequently attached to the support structure so that the facade gives the appearance of a flat glass surface. The dynamic loads are transmitted through the silicone adhesive. To support the dead load of the glass, we recommend a mechanical support that is not visible from the outside.

Advantages of this System

- Attractive appearance without visible frames
- Thanks to its high elasticity, the silicone sealant can transmit the loads at all four sides more efficiently and uniformly, a great advantage when the facade is exposed to high movements, e.g. during earthquakes
- Temperature distribution in the glass is ideal, since there are no cap profiles, which would act as shades. This reduces the risk of glass breakage caused by thermal stresses
- The facade is more energy-efficient as there are no external metal parts and all joints are sealed
- Greater self-cleaning from level glass

2 Optimum Safety



TWO-SIDED STRUCTURAL GLAZING

Mechanical Fixing

In the two-sided structural glazing system, only two mutually opposite glass or panel edges are bonded (horizontally or vertically) to a frame with Sikasil® SG silicone adhesive. The two other mutually opposite sides are fixed mechanically like capped CW systems. Mechanical fixing of the glass element at two sides does not affect the loads on the two bonded sides. Since excessive bending of the glass must be prevented, the minimum dimensions of the joint must not be changed compared to a four-sided system.

Advantages of this System

- High mechanical safety
- The silicone adhesive and the mechanical fasteners help distribute the dynamic forces
- Metal cap profiles can be used as design elements to make the facade seem less severe

For structural glazing silicone adhesive sealants Sikasil® SG see page 16.

3 The Lightness of Glazing



POINT-FIXED GLAZING

Maximal Transparency

In point-fixed glazing systems, the glass elements are fixed to cable systems or metal beams by metal fasteners. These fasteners are embedded in holes in the glass pane with “glass cement” or a plastic jacket. Alternatively they can be bonded to the glass with high-strength silicone adhesives. The glasses can be single panes (e.g. laminated glass in the outer skin of the double skin facade) or insulating units with UV-resistant silicone edge sealing and even with argon filling (Sikasil® IG). Sikasil® WS sealants with their high movement capability are suitable weather sealing solutions for the joints between the glass elements.

Advantages of this System

- High mechanical safety
- Lightweight glass constructions feasible

For the embedding of the metal fasteners into the glass holes and perfect leveling of production tolerances please ask for the Sika® AnchorFix® series.

For UV-resistant weather sealing between the glass panes with Sikasil® WS silicones see page 32.

4 Slim and Energy Efficient Design



STRUCTURAL WINDOW BONDING

Glass Carries the Frame

In bonded windows, the IG units are structurally bonded to the sash frame. The loads are uniformly transferred to the sash. Thus peak stresses are minimized. Architects appreciate the resulting slim sash frames. In conjunction with the superior thermal and sound insulation this makes a compelling argument for the entire design team. Owners are equally delighted by the long service life and minimal maintenance requirement for structurally bonded windows.

Advantages of this System

- Slim sash design and low frame factor
- Improvement of thermal and sound insulation
- Increase of approved wind load
- Reduction of production and service costs
- Up to 90 % lower complaint rate
- Higher resistance against burglar attacks

For details of window bonding see www.sika.com/windows

STRUCTURAL GLAZING

State-of-the-art technology for sophisticated architecture

STRUCTURAL GLAZING MODULES are subject to extremely high stresses. They must accommodate wind and snow loads as well as thermal expansion and permanently transfer the forces to the support structure, while also withstanding weathering over many years.

DURABLE CONSTRUCTION

Sikasil® SG silicone adhesive sealants are used in structural glazing for bonding the glass elements to the metal support frames. The elements may be designed as single glazing or insulating glazing to provide an insulating facade, which forms the complete building envelope and guarantees excellent corrosion protection. Coated multifunctional insulating glazing provides the necessary protection against the sun. Other variants include double skin facades produced with single glazing elements. The elastic joints produced with Sikasil® SG silicone adhesives accommodate movements of the construction elements resulting from temperature changes and shrinkage of construction materials and help to protect the building against the elements. Permanently.

ECONOMICAL BUILDINGS

Structural glazing facades have both technical and economical advantages:

- The factory-produced units can be installed quickly and economically (unitized glazing)
- An efficient insulating facade slashes thermal losses, providing a much improved energy balance
- High solar heat recovery can be taken into account in the energy balance
- Acoustic insulation is improved by insulating glazing and elastic silicone sealant
- These easy-to-clean facades have low maintenance and cleaning costs
- Repairs can be carried out much more economically by quick and easy module exchange

INTEGRATED SYSTEMS

A fully integrated structural glazing system is only possible if a number of conditions are met:

- Project-specific computation of the joint dimensions so that the system can be perfectly executed down to the last detail
- Frame construction exactly tailored to the type of facade
- Frame material and surface finishing must be suitable for the whole facade service life
- Adhesion on original samples of all frame and glazing substrates prior to adhesive application
- Compatibility tests on original samples of sealants and weatherseal gaskets prior to adhesive application. Use only compatible high-quality materials, which meet the strictest construction regulations and international standards
- Factory bonding of the industrially manufactured glass modules with extreme positional accuracy
- Stringent quality control on all the products used, from production through to application

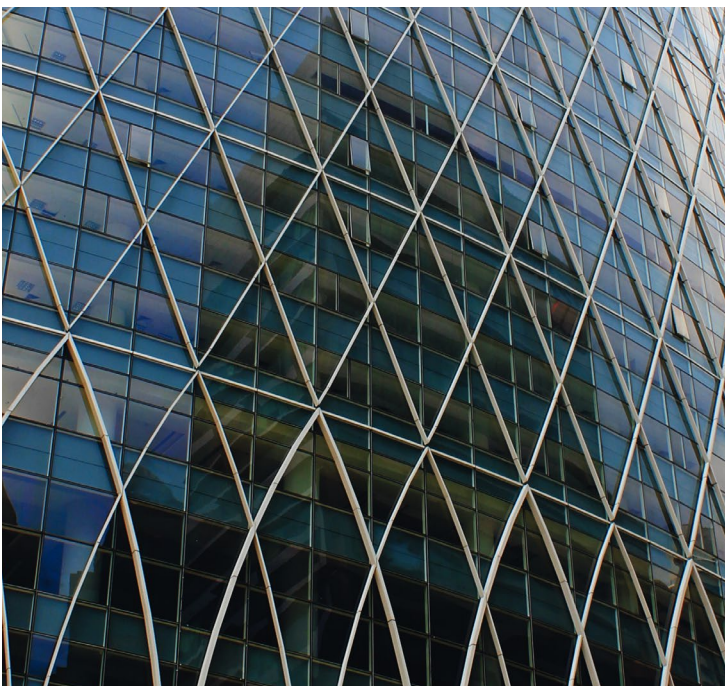

Menara Bank Islam (Menara Wakaf), Kuala Lumpur, 2012
Architects RSP Architects
Facade Puspajaya Aluminium

STRUCTURAL GLAZING – THE PRINCIPLE

The illustration shows a structural glazing module prototype. This drawing is not intended as a construction guide. More elaborate, additional structural elements may be needed to satisfy national construction regulations or project-specific requirements.

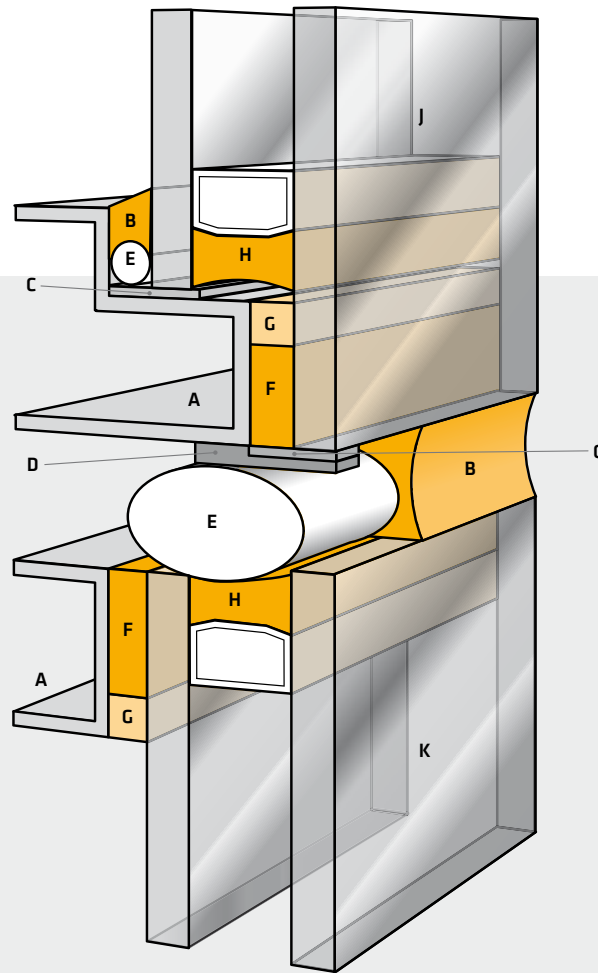

- A** Adapter frame
- B** Weatherseal
- C** Setting block
- D** Mechanical support
- E** Backing material
- F** Structural glazing joint
- G** Spacer tape
- H** Secondary edge seal
- J** Stepped insulating glass unit
- K** Symmetric insulating glass unit

STRUCTURAL GLAZING – CONVINCING ENERGY PERFORMANCE IN ALL DETAILS

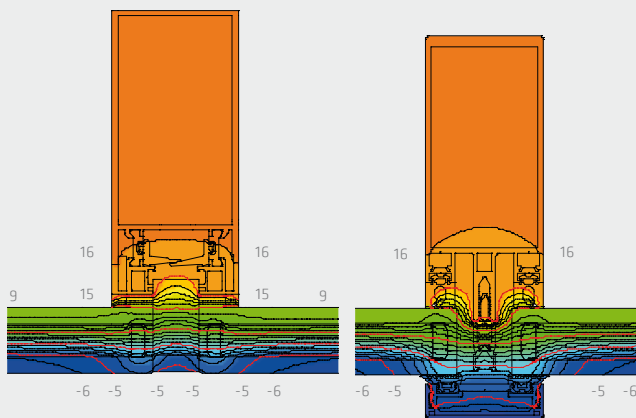
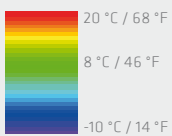

Fig. 1

Fig. 2

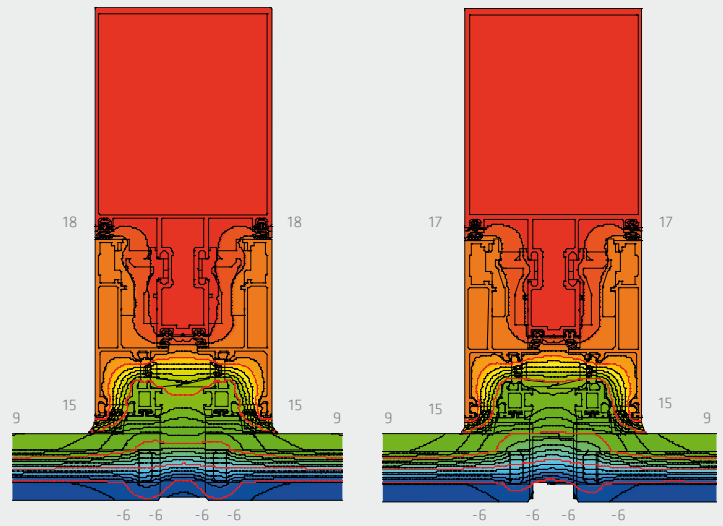

Fig. 3

Fig. 4

Comparison of the U_f values shows the superior energy performance of the SG system (Fig 1: $1.2 \text{ Wm}^{-2}\text{K}^{-1}$) vs capped curtain wall system (Fig 2: $2.9 \text{ Wm}^{-2}\text{K}^{-1}$)

However, the advantage is partially lost if the facade is not properly sealed. See comparison between weather sealants (Fig 3, $1.0 \text{ Wm}^{-2}\text{K}^{-1}$) and gaskets (Fig. 4, $1.7 \text{ Wm}^{-2}\text{K}^{-1}$).

FACADE SYSTEM COMPONENTS – GLASS AND METAL FRAME

GLASS

1. Uncoated Float Glass

Float glass is generally suitable for all bonded glass facades. To reduce the risk of damage from glass breakage, use tempered or laminated safety glass (e.g. polyvinyl butyral, PVB, or ionomers). Sikasil® SG silicone adhesives ensure excellent adhesion to tempered glass without additional tests. Where laminated glass is used, we recommend carrying out compatibility tests.

2. Pyrolytic Coatings for reflective Glass (Hard Coatings)

Coated glass optimizes the thermal performance of the facade while providing a particularly attractive optical effect. Pyrolytic coatings (hard coatings) of metal oxides are ideal for structural glazing, since they resist environmental conditions. Before application of Sikasil® SG and IG silicone adhesives, adhesion tests must be performed on the coatings.

3. Magnetron Coatings for lowE Glass (Soft Coatings)

These coatings contain precious metals (e.g. silver) and are thus very often mechanically and chemically not resistant enough for use in structural glazing. If necessary, strip off the coating at the bonding area. Adhesion must therefore be tested on the abraded specimens, since abrasion represents a severe modification of the surface, and is subject to various process parameters. Always follow the glass manufacturer's instructions.

4. Ceramic Coatings

Ceramic coatings are used predominantly in the opaque spandrel area. At the edge area of vision glass, they conceal color deviations between insulating glazing primary and secondary edge seal and structural glazing adhesive. The adhesive strength of Sikasil® SG silicone adhesives has been proven in numerous projects and tests according to the European guideline for bonded glass structures (EOTA ETAG 002). However, since the composition of the coatings may vary greatly, individual adhesion tests must be carried out for each project.

ADAPTER FRAME

The adapter frame is usually made of the following materials:

- Anodized aluminum
- Powder-coated aluminum
- PVDF-coated aluminum
- Stainless steel

Sikasil® SG silicone adhesives and Sikasil® WS sealants adhere very well to these materials. Sika carries out additional tests to check the representative surface quality used in every individual project.

Furthermore the organic coating system has to be approved for structural glazing application by both coating producer and coater (e.g. complying EOTA ETAG 002 part 2). The durability of the coating system must be adequate to the life expectancy of the structural bonding application.

On organic coatings, tried-and-tested pretreatment agents like Sika® Aktivator-205 and Sika® Primer-790 have proven to accelerate the formation of adhesion and optimize the adhesion profile and durability.

Opera House, Harbin, 2014
Architects MAD Architects; Facade Shenyang YuanDa



Sikasil® SILICONE SEALANTS IN DETAIL

SPECIALIZED PRODUCTS

High-modulus Sikasil® SG silicone adhesive sealants offer the best properties for this purpose. The latest development with highest design strength is described on page 22. Special high-modulus Sikasil® IG silicone secondary sealants allow very low argon loss rates in structural glazing facades. Sika's low-modulus Sikasil® WS weatherseals accommodate the movements between the structural glazing modules and durably seal them against wind and water. The elastic seal can even reduce damage in small to medium-scale earthquakes and bomb blasts. Sikasil® FS silicones comply with international fire standards.

TAILORED PRODUCTS

Silicone sealants are classified according to their curing mechanism into acidic (which emit acetic acid on curing) and neutral systems (which emit oxime or alcohol on curing). For facades, solvent-free, non-corrosive neutral technology is used almost exclusively. The exceptions are all-glass structures that can also be sealed with acetic-curing sealants.

TYPICAL PROPERTIES OF NEUTRAL SEALANTS

- A wide range of adhesion properties for a variety of applications
- Outstanding adhesion and bonding power to glass and metal surfaces
- Early load-bearing, thanks to high initial elasticity
- Reliable and non-corrosive to sensitive materials when used in movement and expansion joints
- Application-specific curing time with different vulcanization rates and optimum curing
- Uniform long-term elasticity
- Good elastic recovery
- Strong and durable
- Outstanding weathering and ageing resistance
- Extremely good UV and oxidation stability
- Good chemical resistance
- Resistant and flexible even with extreme temperature fluctuations from -50 °C to +150 °C (-58 to 302 °F)
- Low shrinkage in vulcanization

SEALANT COMPOSITION

Sikasil® silicone sealants generally consist of the following components:

- Silicone polymer
- Silicone plasticizer
- Silicone cross-linker
- Silicone adhesion promoter
- Reinforcing fillers (e.g. fumed silica)
- Possibly non-reinforcing fillers, such as silicates, chalks, etc.
- Optionally, additives such as emulsifiers, pigments and fungicides

California Academy of Science, Exhibition and Research Center, 2008
Architects Renzo Piano Building Workshop, Stantec Architecture; Facade Josef Gartner (DE)



ONE- VS. TWO-COMPONENT SILICONES

Silicone sealants and adhesives are available both as one-component and two-component products. The number of components does not have an influence on the mechanical properties, but has some consequences on the product application. Whereas one-component products are easy to use and mainly applied on site as weather proofing sealants from foil packs or cartridges, the two-component products are preferably factory applied with machines from drums and pails and mainly used as high-modulus adhesives. For available packaging, please check the relevant product datasheets or ask your Sika contact. The table on the right summarizes the main product



top:
Application machine for 2-part sealants out of drums and pails (factory application)

bottom:
Gun application of 1-part sealants out of foil packs and cartridges (on-site application)



PROPERTIES AND APPLICATION CHARACTERISTICS OF ONE- AND TWO-COMPONENT Sikasil® SILICONE SEALANTS

One-Component Systems

Ready-to-apply grade. Already contains cross-linker and catalyst

Supplied in cartridges or foil packs, can be used immediately

Easy to use (field glazing in two-sided structural glazing, repair glazing, weatherseals)

Require atmospheric moisture for curing at room temperature

Curing starts at the surface and continues inwards relatively slowly

Curing rate depends on relative air humidity, temperature and joint depth (see Fig. 5)

Minimum time span between bonding and assembly of the structural glazing elements: 2 to 4 weeks depending on air humidity and joint dimensions

Joint bite limited to maximum 15 mm, otherwise curing takes too long and there is a risk of cracking

Two-Component Systems

Base compound and hardener are mixed during application

Supplied in drums and pails, components must be mixed by machine

Execution under controlled conditions in the factory resulting in higher quality of the bond

No atmospheric moisture required for curing

Once the components are mixed, curing begins uniformly throughout the joint with a gradual increase in viscosity

Curing rate depends virtually only on the temperature

Minimum time span between bonding and assembly of the structural glazing elements: 3 to 5 days, depending on frame materials

Should be used for thicker silicone adhesive sealant layers. Greater joint bite than 15 mm possible, since considerably higher curing rate and lower volume shrinkage on curing.

Efficient factory prefabrication of structural glazing elements possible. Elements are faster to transport and install

CHARACTERISTICS OF Sikasil® SILICONE SEALANTS

One-component silicones

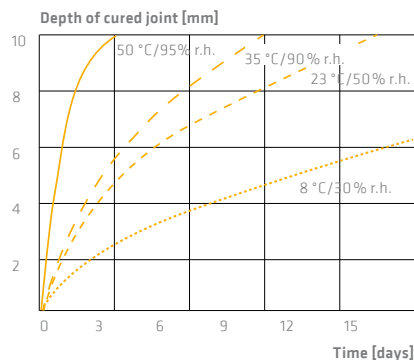

Fig. 5: Curing rate of one-component silicones such as Sikasil® SG-20 or Sikasil® WS-605 S

Two-component silicones

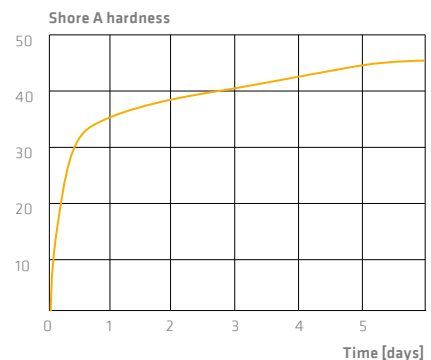

Fig. 6: Shore A hardness in the curing of two-component silicones, such as Sikasil® SG-500 or Sikasil® IG-25, as a function of time

MECHANICAL PROPERTIES

MECHANICAL PROPERTIES

Sealants are classified (e.g. according to ISO 11600 or ASTM C920) by their mechanical properties.

Tensile Stress

This is the quotient of the tensile force measured at a particular elongation and the initial cross-section of the test specimen. For classification as a low-modulus sealant according to ISO 11600 (e.g. ISO 11600 25 LM), this must have a tensile stress of less than 0.45 N/mm² at 20 °C / 68 °F (compl. ISO 8339).

Important: For comparing mechanical data, the shapes of the test specimens are important. Dumbbell-shaped specimens (ISO 37, ISO 527, ASTM D 412) show much higher mechanical values than H-specimens (ISO 8339, ASTM C1135), which are more similar to actual joint geometries and are therefore usually used for structural glazing tests.

Tensile Strength

This is the quotient of the maximum measured force and the initial cross section of the test specimen.

Elongation at Break

This is the quotient of the change in length measured at the instant of tearing and the initial measured length of the test specimen.

Shore A Hardness

This is the penetration hardness of polymers (compl. ASTM D2240, ISO 868). It depends on the modulus of elasticity and the viscoelastic properties of the material. Higher Shore A values ensure a harder material. High-modulus structural glazing silicone adhesive sealants and insulating glass secondary sealants usually have Shore A values of over 30. The values for weatherseals are usually between 15 and 30.

MOVEMENT CAPABILITY

The movement capability is the maximal allowable elongation and compression that a joint sealant undergoes during service. In the case of silicone sealants according to ISO 11600, it is between 20 and 25 % of the initial width. According to ISO 9047, classification 25 is based on elongation and compression cycles with an amplitude of $\pm 25\%$. In ASTM C920 movement capabilities of $\pm 50\%$ or even $+100/-50\%$ are classified.

ADHESION

Silicone sealants adhere very well to many substrates. The adhesion depends on the type of material to be bonded, the stresses, the type of adhesive bond and surface pretreatment. The surfaces must be absolutely clean and grease-free. Before the start of sealant application on any construction projection, always carry out adhesion tests on the surfaces in question.

H-SPECIMEN VS. DUMBBELL

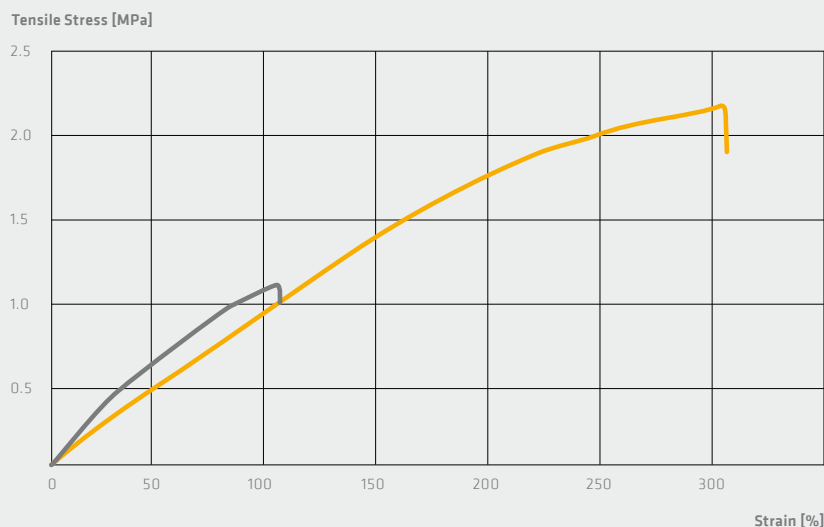
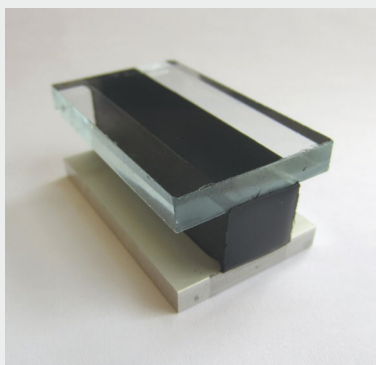

Fig. 7: Stress-strain curve, comparison of H-specimens and dumbbell

The grey stress-strain curve of H-specimen of Sikasil® SG-500 (compl. ASTM C1135 / ISO 8339) shows the behavior of the adhesive in the joint function.

The orange stress-strain curve of dumbbell of Sikasil® SG-500 (compl. ASTM D412 / ISO 37 / ISO 527) shows the mechanical properties of the adhesive for FE modeling. For comparing datasheet values check the test methods first. Dumbbells always show much higher mechanical values than H-specimens.



BEHAVIOR AND RESISTANCE

WEATHERING AND UV RESISTANCE

Silicone sealants have better weathering and UV resistance than other joint sealants. Their physical properties do not change significantly, even after years of outdoor weathering.

COMPATIBILITY WITH COATING MATERIALS

Silicone sealants usually adhere well on coating materials (powder coatings, liquid paints and varnishes) of the construction materials, but this should always be tested. However, standard silicone sealants cannot be painted with liquid coating material (paints or varnishes). Streaking and running of these coatings usually occur during application.

Important: Most of the coating materials used in building construction and in almost all window constructions are less elastic than sealants. A continuous coating may therefore tear if the dimensional change of the sealant is greater than the elasticity of the coating. Elastic sealants in settlement joints must therefore never be completely coated. Only sealants subject to low movements up to approx. 5% can be coated completely. Sealants coming into contact with coatings must be compatible with them (in conformity with DIN 52452).

CHEMICAL RESISTANCE

Vulcanized silicone sealants have good resistance to weak acids and alkalis, polar solvents and salt solutions. Silicone sealant swells to a greater or lesser extent in solvents such as ketones, esters, ethers, aliphatic, aromatic and chlorinated hydrocarbons. However, it returns to its original shape after evaporation of the solvents.

HIGH AND LOW TEMPERATURE BEHAVIOR

The stress/strain value (modulus) of silicone sealants – unlike organic sealants – remains nearly constant over a wide temperature range from -30 to $+80$ °C (-22 to 176 °F). The tensile strength increases towards lower temperatures. Silicone sealants are thus ideal for compensating for joint expansions occurring as construction elements cool to low temperatures. The tensile stresses in the joint flanks are not increased, and there is reduced risk of loss of adhesion and consequent adhesive fracture. Below -50 °C / -58 °F, there is partial crystallization of the silicone elastomers and the sealant hardens. At -123 °C / -189 °F (the glass transition temperature) embrittlement occurs. Silicone sealants are extremely heat resistant. In dry air up to $+150$ °C / 302 °F, all grades retain virtually their full elasticity. Special silicone sealant grades are even heat resistant up to $+250$ °C / 482 °F. It is important that silicone elastomer should be fully vulcanized before it is subjected to high temperatures, and that the curing by-product has evaporated completely. Heat resistance can be further enhanced by subsequent annealing at slowly increasing temperature and with good ventilation.

SHELF LIFE

If stored in the original sealed containers at temperatures below 25 °C / 77 °F, silicone sealants have a shelf life of at least 12 months, and some grades at least 18 months.

GAS AND WATER VAPOR PERMEABILITY

At room temperature, the gas permeability of silicone sealants is about ten times higher than that of natural rubber. From 100 °C to 150 °C (212 °F to 302 °F), the permeability values are approximately the same. The water vapor permeability according to DIN 53122, climate D, film thickness 2 mm, is approx. $20 \text{ gm}^{-2}\text{d}^{-1}$.

SOME BASIC RULES – RESTRICTIONS ON USE

In structural glazing high loads are to be transferred to the sub-construction by high-modulus structural glazing adhesives. Thus low-modulus silicone sealants must not be used for structural glazing bonding.

Acetoxy-curing silicone sealants are incompatible with alkaline substrates such as mortar and concrete, and with corrosion sensitive metals and alloys such as lead, zinc, copper, brass and ferrous metals. Neutral silicones, e.g. Sikasil® WS-605 S or Sikasil® WS-305, shall be used instead.

Standard silicone sealants must not be used for sealing settlement joints and expansion joints between porous natural stone (e.g. granite, marble, sandstone, etc.). There is a risk of staining. We recommend Sikasil® WS-355 N or Sikasil® WS-605 S instead. See page 34.

Standard silicone sealants can cause environmental stress cracking in contact with pre-stressed acrylic and polycarbonate construction elements. Further product information is provided in the data sheets.

Fungicide-containing sealants, e.g. sanitary sealants, must not be used for the production of aquaria.

Silicone sealants do not adhere to polyethylene and polytetrafluoroethylene. Please ask us for suitable pretreatment methods, e.g. corona treatment.

Contact with organic elastomers (such as EPDM and Neoprene) can not only cause discoloration of the sealant but can also reduce its mechanical strength and cause adhesive failure. Please ask us for compatible recommendations.



COEFFICIENT OF EXPANSION

The coefficient of cubic expansion of silicone sealants depends on the nature and the amount of fillers used. It is in the range 4 to $8 \times 10^{-4} \text{ K}^{-1}$.

The coefficient of linear expansion is approximately a third of the cubic expansion, i. e. from 1 to $3 \times 10^{-4} \text{ K}^{-1}$.

THERMAL CONDUCTIVITY

The thermal conductivity of silicone sealants depends on the nature and the amount of fillers used. It is in the range from 0.15 to $0.3 \text{ W K}^{-1} \text{ m}^{-1}$ at room temperature (e.g. EN 12664, ASTM D5930-01).

PHYSIOLOGICAL CHARACTERISTICS

All silicone sealants emit by-products on curing. They may be acetic acid, alcohols or oximes, depending on the sealant grade. We therefore advise users to read the data sheet and safety data sheet in advance. In general,

silicone sealants should be applied in a well-ventilated room. Vulcanized silicone sealants are non-toxic. Special grades are available for contact with foods and drinking water.

MICROBIAL RESISTANCE

Unlike organic sealants, silicone sealants are not attacked or degraded by microbes (bacteria or fungi). However, microbes can accumulate on the surface of dirty silicone sealants, particularly in warm and moist conditions occurring in bathrooms and kitchens. This causes discolored patches on the sealant surface without its mechanical properties changing. For warm and moist applications, therefore, a fungicide-containing sealant should be used.

TERMINOLOGY

Adhesion Tendency of a solid surface to stick to a second phase, which may be a liquid or a solid film.

Adhesion Loss Undesirable separation of the adhesion bond, e. g. separation of a joint.

Adhesion Value Stress of an adhesive bond, or the force necessary to separate the bond.

Cohesion The integrity of substances as a result of chemical bonding or physical intermolecular forces.

Cohesive Fracture Undesirable material fracture, e. g. within the joint.

SOME RELEVANT INTERNET LINKS

www.aia.org
www.archdaily.com
www.archinform.de
www.architecture.com
www.architectureweek.com
www.ctbuh.org
www.emporis.com
www.eota.be
www.gpd.fi
www.igcc.org
www.igsmag.com
www.skyscrapercenter.com
www.uia-architectes.org

SPECIAL SOLUTIONS

Sika has developed special products to cover most challenges in construction industry.

We will be pleased to advise you on any type of application problem and find a solution.

Sikasil® SG SILICONE ADHESIVES

STRUCTURAL BONDING

Sika has developed one-component and two-component silicone adhesive sealants for structural glazing and insulating glazing applications, and each features specific advantages. Which of these systems is best for a particular application depends first and foremost on the specific requirements. Both systems offer maximum quality and maximum safety in every respect.

In addition they are characterized by the following special properties:

- High tensile strength
- High elastic recovery
- Low volume shrinkage on curing

Sikasil® SG-500

- Two-component SG system
- For machine application
- Neutral curing
- Fast vulcanization and through-cure
- Excellent UV and weathering resistance
- High mechanical strength
- ETA certified and CE-marked
- Complies with ASTM C1184, C920, class 12.5, ETAG 002, ETA approved (ETA 03/0038), marked with CE and SNJF VEC, EN 13022, EN 1279-2, -4

Sikasil® SG-500 CN

- Two-component SG system
- For machine application
- Neutral curing
- Fast vulcanization and through-cure
- Excellent UV and weathering resistance
- High mechanical strength
- Complies with ASTM C1184, ASTM C920 class 25, GB 16776-2005

China Steel HQ, Kaohsiung City, 2011
Architects ARTECH INC; Facade CWCO



Sikasil® SG-500 S

- Two-component SG system
- For machine application
- Neutral curing
- Fast vulcanization and through-cure
- Excellent UV and weathering resistance
- High mechanical strength
- Complies with ASTM C1184, ASTM C920 class 25, GB 16776-2005

Sikasil® SG-550

- Two-component SG system
- For machine application
- Neutral curing
- Fast vulcanization and through-cure
- Excellent UV and weathering resistance
- Extremely high mechanical strength
- Good processing properties on hydraulic pump systems*
- High design strength for smallest SG joints
- Complies with ASTM C1184, ASTM C920, class 12.5, ETAG 002 and EN15434, ETA approved (ETA 11/0392) marked with CE and SNJF VEC

* e.g. Reinhard Technik, Ecostar 250, Lisec TAL 50 and TAL 60, TSI Mastermix XL and XS, Dopag Visco-Mix H200; pneumatic pumps have to be tested

Sikasil® SG-20

- One-component SG system
- Neutral curing
- Odorless
- UV-resistant and weather-resistant
- Very high mechanical strength combined with high elasticity
- Ready to process
- Complies with ASTM C1184, ASTM C920 class 25, ETAG 002, ETA approved (ETA 06/0090), marked with CE and SNJF VEC, EN 13022, GB 16776-2005

DID YOU KNOW?

With 0.20 N/mm², Sikasil® SG-550 achieves the highest ETA approved SG design stress in tension in the market. For more details see page 22.

The latest Application Guidelines can be downloaded from www.sika.com/ffi-downloads



COMPATIBLE SPACERS

Sika® Spacer Tape HD has mechanical properties perfectly adjusted to meet the curtain wall requirements. They provide the essential UV resistance and durability, and are the perfect installation aids for structural glazing elements. The open cell structure of the Sika® Spacer Tape HD is permeable to air humidity and thus increases the speed of vulcanization of one-component Sikasil® SG adhesive sealants. Two-component adhesives reach full mechanical strength only if curing by-products can be released freely. With joints bites bigger than 30 mm only open-cell Sika® Spacer TapeHD shall be used. These PU foam tapes have been thoroughly tested for compatibility with all Sikasil® silicone sealants, and a guarantee to this effect is provided.

Sika® Spacer Tape HD is available in the standard thicknesses of 3.2, 4.8, 6.4, 8.0 and 9.5 mm.

STANDARDS AND GUIDELINES

A wide variety of local standards and guidelines have become established worldwide. The most important are:

In Europe

EOTA ETAG No. 002-1998 (2012): a guideline on the application and testing of SG adhesives, which is adhered to in EU states and takes local regulations into account.
CSTB 3488: describes the French SG regulations for adhesives.

In the USA

ASTM C1184-18: comprehensive SG adhesive specification standard.
ASTM C1401-14: guideline for SG applications.
ASTM C1392-20: guide for SG failure evaluation
ASTM C1487-19: guide for SG remedying

In China

GB 16776-2005: SG certification standard
JGJ 102: SG design standard
JC/T471-2015: Insulating glass secondary sealant for curtain wall of buildings, doors and windows
JC/T475-2015: Silicone structural sealants for building curtain walls

In countries without own structural glazing standard, ASTM C1184 / ASTM C1401 or EOTA ETAG 002 are usually applicable.

Sika offers a complete set of Sikasil® SG, IG and WS products including Sika® Spacer Tape HD and the IG butyl in a harmonized shade of grey. Your Sika sales manager will be pleased to give you further details.

For details of Structural Glazing see: www.sika.com/ffi-sg



JOINT DESIGN

CORRECT PLANNING IS ESSENTIAL

In structural glazing, the adhesive joints are planned according to optical requirements, but planners shall also take into account dimensional changes in the adjacent parts under the effect of temperature and the movement capability of the silicone adhesive. The joint design thus shall combine design with functionality.

PLEASE NOTE

SEVEN ESSENTIAL JOINT DESIGN CRITERIA:

1. The structural joint must be able to freely accommodate tensile, compressive, and shear movements between the joint edges. Adhesion on three sides must be avoided to ensure the correct joint performance and to avoid over-stresses on the joint (see drawing D on page 20).
2. For one-component structural glazing adhesives, such as Sikasil® SG-20 or Sikasil® SG-20 S, the maximum joint bite is limited to 15 mm, or to 20 mm in combination with an open-cell Sika Spacer Tape HD. For two-components structural glazing adhesives, such as Sikasil® SG-500, Sikasil® SG-500 S, Sikasil® SG-500 CN or Sikasil® SG-550, the maximum bite is limited to 30 mm, or to 50 mm in combination with an open-cell Sika Spacer Tape HD. Consult Sika Technical Department for details.
3. The ratio of joint bite h to joint thickness e should be at least 1:1 and at most 3:1.
4. The minimum joint bite is always 6 mm, irrespective of the calculated value.
5. The joint thickness e should be at least 6 mm.
6. Always round the result up, never down.
7. The structural joints must not be subjected to permanent constraint forces as a result of the installation, movement of the building, etc.

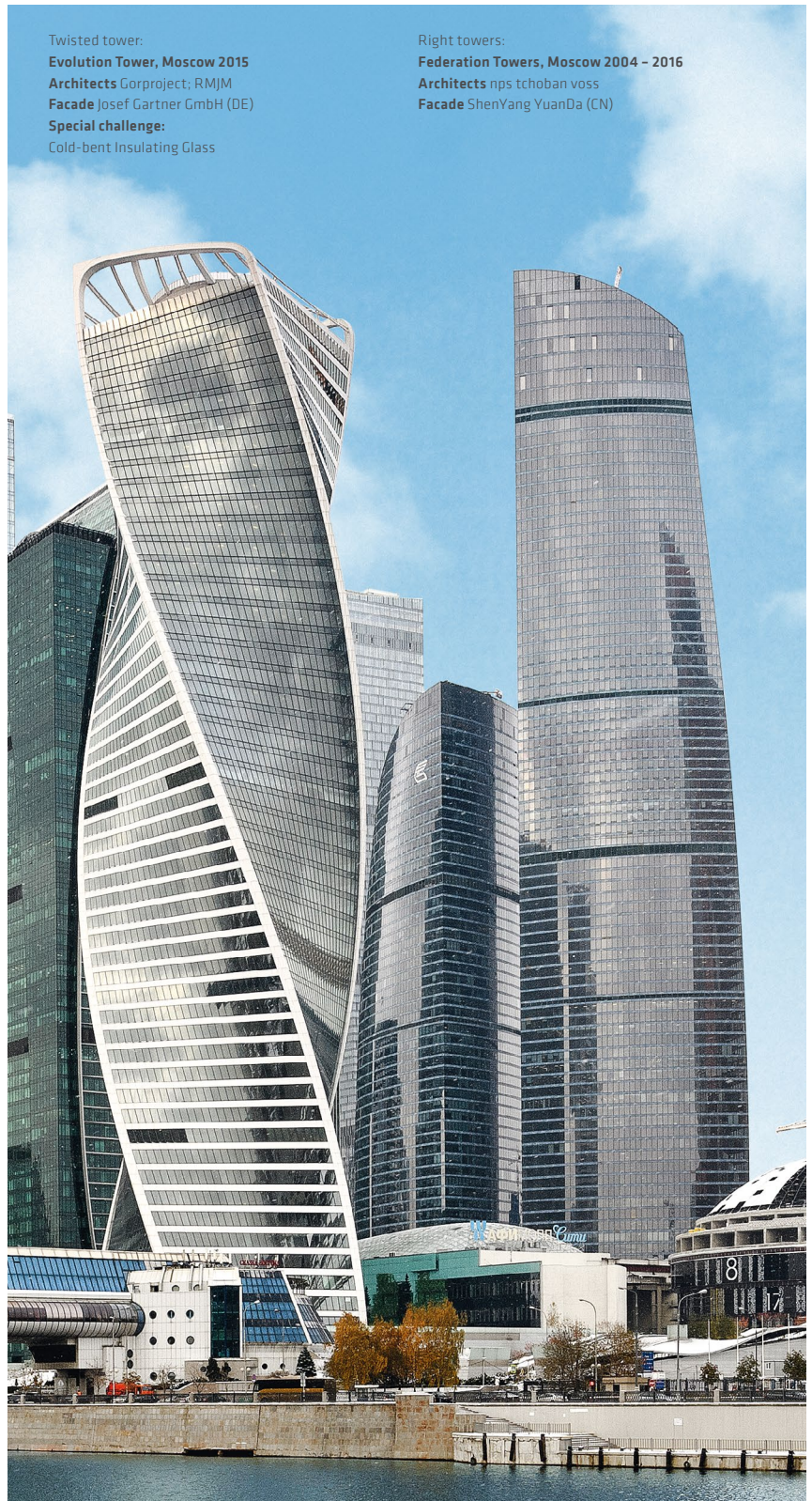

CALCULATING JOINT BITE h

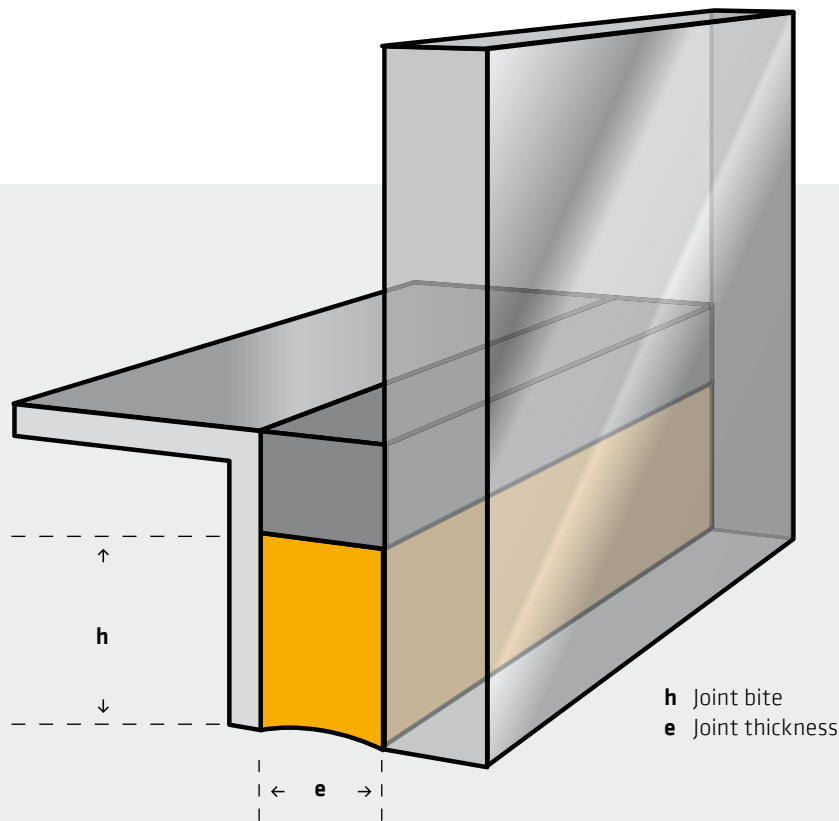

h Joint bite
e Joint thickness

Joint bite h as a function of the wind load in supported constructions:

$$h = \frac{a \times w}{2 \times \sigma_{\text{dyn}}}$$

h minimum bite of the adhesive joint [mm]
a length of the short edge of the glass pane or of the element [m];
w maximum wind load to be expected [kN/m²] (100 kp/m² = 1 kPa = 1 kN/m²)
σ_{dyn} maximum adhesive stress for supported constructions [MPa].
For **σ_{dyn}** values of Sikasil® products see page 52.

Example 1 (wind load calculation with Sikasil® SG-500 and according to ETAG 002 approach):

Glass dimensions:
Height: 2.5 m
Width: 1.5 m

Maximum wind load = 4.0 kN/m²

Pane dimensions: 2.5 m x 1.5 m

Result: 21.43 mm

The joint bite is thus at least 22 mm

Joint bite h as a function of the dead load in non-supported constructions:

$$h = \frac{G \times 9.81}{l_v \times \Gamma_{\infty}}$$

h minimum bite of the adhesive joint [mm]
G weight of the glass or of the element [kg]
l_v length of the vertical adhesive bond [mm] complying with ETAG 002. In ASTM C1401 I is the whole perimeter of the pane, vertical l_v plus horizontal l_h
Γ_∞ permissible stress of the adhesive for non-supported constructions [MPa]
For **Γ_∞** values of Sikasil® products see page 52.

Example 2 (dead load calculation with Sikasil® SG-500 and according to ETAG 002 and ASTM approaches):

Glass dimensions:
Height: 2.5 m
Width: 1.5 m
Thickness: 10 mm

Density of glass: 2.5 kg/dm³

Result ETAG: 17.52 mm

The joint bite is thus at least 18 mm.

Result ASTM: 16.42 mm

The joint bite is thus at least 17 mm.

Joint bite h as an interaction of combined tension and shear loads: Mohr tension circle

$$h_{\text{tot}} = \frac{h_{\text{tensile}}}{2} + \sqrt{\left(\frac{h_{\text{tensile}}}{2}\right)^2 + h_{\text{shear}}^2}$$

h_{tot} minimum bite of the adhesive joint [mm]
h_{tensile} bite of the adhesive joint from tensile load, e.g. wind load [mm]
h_{shear} bite of the adhesive joint from shear load, e.g. dead load [mm]

For a combined load condition, the simultaneous presence of shear and tensile stress must be considered. Design criteria for evaluating the interaction of tension and shear are also provided by ASTM C1401-14.

Example 3 (combination of wind and dead loads with Sikasil® SG-500 and ETAG 002 approach):

h_{tensile}: 22 mm

h_{shear}: 18 mm

Result: 32.09 mm

The joint bite is thus at least 32 mm.

In all structural glazing constructions, the adhesive bond is subject to considerable shear movements. The joint thickness must therefore be designed so that the allowable deformation rate of the adhesive is not exceeded.

Factors to be considered for Calculating the Joint Thickness e

- Panel dimensions
- Maximum and minimum panel frame and bonding temperatures
- Coefficients of thermal expansion of the materials to be bonded
- Minimum joint thickness of 6 mm, but it should be defined considering the above mentioned factors

CALCULATING THE JOINT THICKNESS E

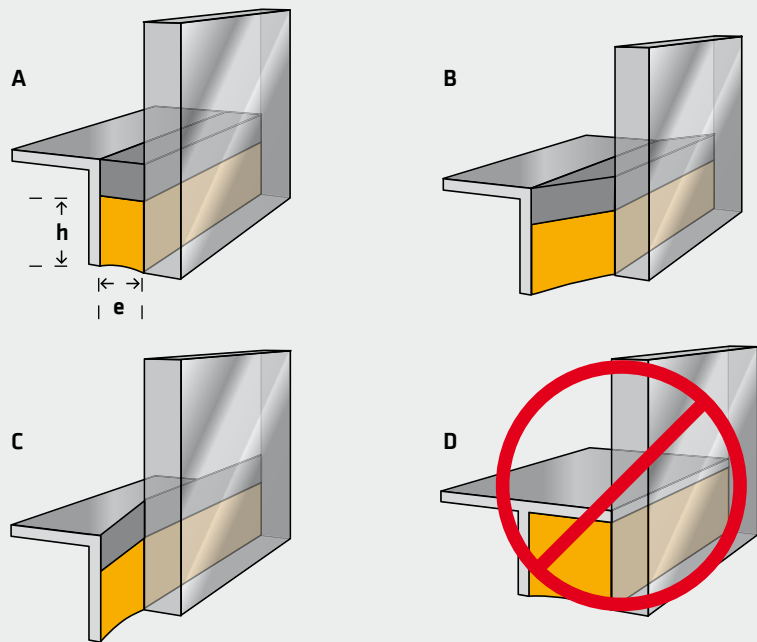

- A** Right joint dimension in its original state (h = joint bite, e = joint thickness).
- B, C** Besides tensile and compression movements, the adhesive bond also accommodates shear movements in all directions.
- D** Bonding on three sides must be avoided. Detail D is forbidden!

PLEASE NOTE

CONSIDER ALL CAUSES OF STRESS IN THE JOINT.

1. All causes of movement must be taken into account:

- Thermal mismatch between the glass and the support structure due to different thermal expansion coefficients. If the joint dimensions are to be the same for a complete construction project, they must be calculated according to the dimensions of the largest pane.
- Other causes, such as shrinkage, subsidence or locally confined stresses.

2. Observe all tolerances. These include the tolerances for cutting glass, and/or metal, and installation tolerances.

3. The application temperature must be between +5 °C / 41°F and +40 °C / 104° F.

4. Avoid three-sided adhesion of the sealant so as not to restrict joint movement. Detail D (right figure) is absolutely forbidden!

Osotspa, Bangkok, 2015
Architects Plan Architects; Facade Asia Aluminum & Glass



1. Deformation of the SG Structure

$$\Delta l_{v,h} = l_{v,h} \times [(\alpha_f \times \Delta T_f) - (\alpha_g \times \Delta T_g)]$$

Calculation of the deformation of the long and short panel edges to take account of the different expansion and contraction behavior of glass and adapter frame (thermally induced movements in the shear direction).

- $\Delta l_{v,h}$ change in length [mm]
- l_v vertical reference length [mm]
in dead load supported systems:
 l_v = total height of glass unit
in non-supported systems:
 l_v = half the height of glass unit
- l_h horizontal reference length
 l_h = half the width of glass unit [mm]
- ΔT_f maximum frame temperature - minimum bonding temperature (approx. 30 k - 60 k)
- ΔT_g maximum glass panel temperature - minimum bonding temperature (approx. 30 k - 60 k)
- α_f expansion coefficient of the frame material
(aluminum: $23.8 \times 10^{-6} \text{ K}^{-1}$,
stainless steel: $12 \times 10^{-6} \text{ K}^{-1}$)
- α_g expansion coefficient of glass $9 \times 10^{-6} \text{ K}^{-1}$

2. Total Movements

$$\Delta l = \sqrt{\Delta l_v^2 + \Delta l_h^2}$$

The calculated deformations of the long and short panel edges yield the total movements according to the formula above (Pythagoras' theorem).

- Δl total change in length [mm]
- v vertical
- h horizontal

According to ETAG 002 a joint ratio of $e \leq h \leq 3e$ is advisable. For a joint ratio $> 3:1$, the bending effects in the elastic joint must be considered.

Example 4 (with Sikasil® SG-500):

Glass dimensions: 2.5 m x 1.5 m
(see example 1)
Temperature difference frame: 30 K
Temperature difference glass: 60 K

Result Step 1: $\Delta l_v = 0.44 \text{ mm}$
Result Step 2: $\Delta l = 0.45 \text{ mm}$

G (SG-500): 0.50 MPa
 Γ_{des} (SG-500): 0.105 MPa
 $\Delta l_h = 0.13 \text{ mm}$
Result Step 3a (ASTM): $e = 1.41 \text{ mm}$
Allowable deformation rate: 5%
Result Step 3b (ETAG): $e = 2.14 \text{ mm}$

Minimum joint thickness (e) is 6 mm, but due to the recommended ratio of $h:e \leq 3:1$ the joint width shall be 8 mm for asupported construction (Example 1) and 11 mm for a non-supported construction (Example 2).

3a. Calculation of the minimum joint Thickness e (ASTM C1401)

$$e \geq \frac{\Delta l}{\sqrt{2c_{Allow} + c_{Allow}^2}}$$

- c_{Allow} Allowable deformation rate
For values of Sikasil® products, see page 52

3b. Calculation of the minimum joint Thickness e (ETAG 002)

$$e \geq \frac{(G \times \Delta l)}{\Gamma_{des}}$$

- G Shear modulus ($G = E/3$) (MPa)
- E Tensile modulus (MPa)
- Γ_{des} Design value of dynamic shear strength (MPa)
For Γ_{des} values of Sikasil® products see page 52

For support in joint calculations, please contact your Sika Facade, Fenestration, Insulating Glass (FFI) Competence Center. For standard conditions, calculate your joint dimensions with the Sika Joint calculator:

www.sika.com/ffi-joint-calculator



DID YOU KNOW?

All Sikasil® IG secondary sealants and SG adhesives carrying an ETA are ETAG 002 approved for type III and IV for systems without mechanical dead load support.

ULTIMATE SAVINGS BY STRENGTH

Sikasil® SG-550

Sikasil® IG-25 HM Plus

Since the beginning of structural glazing, the design tensile strength has been fixed at 0.14 N/mm². This started to change in 2006 when the design tensile strength of Sikasil® SG-20 was rated with 0.17 N/mm². Sika offers two innovative products with a mechanical strength outperforming all existing insulating glass and structural glazing silicone adhesives. In the latest ETA approvals issued in 2011 the IG secondary edge seal Sikasil® IG-25 HM Plus has been evaluated with 0.19 N/mm². The structural glazing adhesive Sikasil® SG-550 is even rated with unmatched 0.20 N/mm². With almost 90% elongation at break it can accommodate high movements in the SG modules. Figures 8 and 9 demonstrate impressively the improvements compared to standard silicone products on the market.



20 Fenchurch Street, London, 2015
 Architects Rafael Viñoly Architects, Adamson Associates
 Facade Permasteelisa, Josef Gartner (DE)

	Standard Silicone	High strength Silicone	Saving/Reduction
Sikasil® Products	IG-25, IG-25 S SG-500, SG-500 S SG-500 CN	IG-25 HM Plus SG-550	
IG sealant dimension	17 x 12 mm	13 x 12 mm	25 % volume
SG joint dimension	30 x 9.5 mm	21 x 6.4 mm	60 % volume
Size of spacer tape	9 x 9.5 mm	6 x 6.4 mm	55 % volume
Width of mullion	95 mm	70 mm	26 % width

DID YOU KNOW?

In bomb blast tests Sikasil® SG-550 outperformed standard SG adhesives impressively, allowing bondline reductions up to 50%. For detailed results contact the Technical Department of Sika Industry.

Sikasil® SG-550

High mechanical strength and design factors:

- Tensile strength: 1.6 N/mm²
- Design tensile strength σ_{dyn} : 0.20 N/mm²
- Design shear strength Γ_{∞} : 0.013 N/mm²

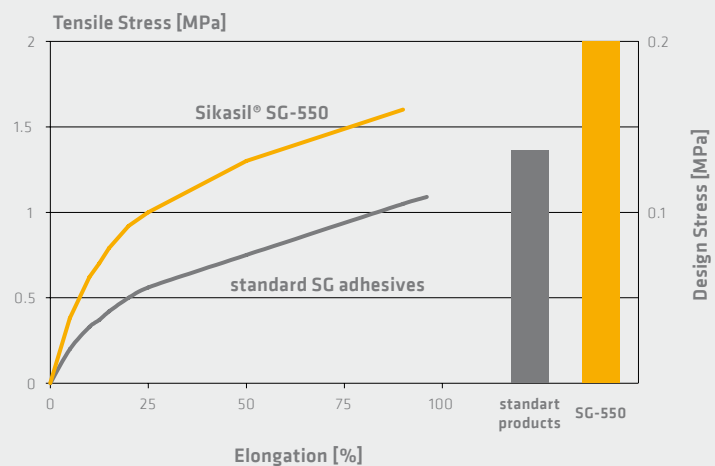
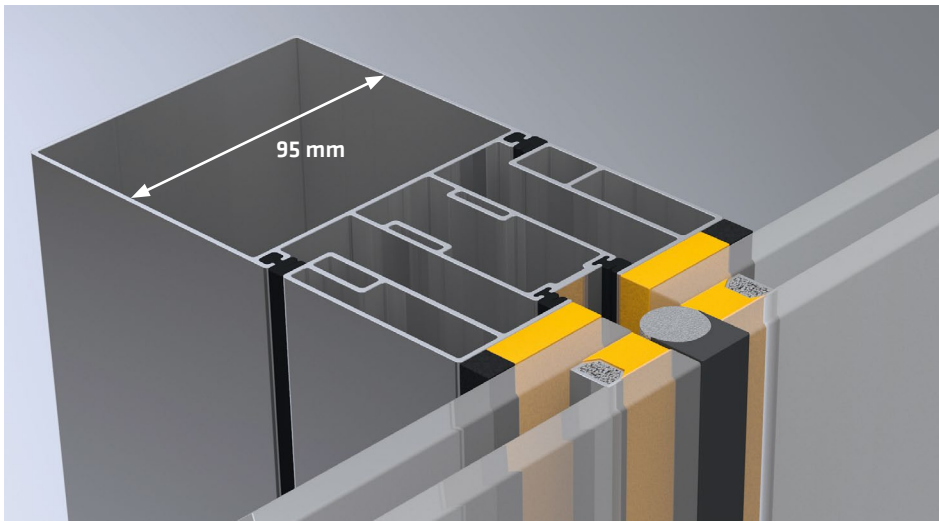

Fig. 8: Comparison of tensile stress and design strength of Sikasil® SG-550 with standard SG adhesives



COMPARISON: STANDARD PRODUCT

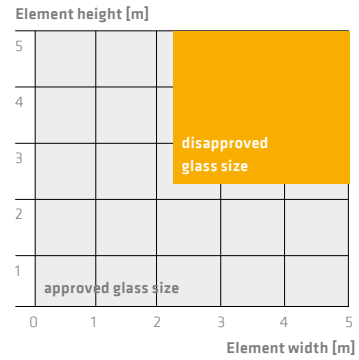

Fig.10: Feasible SG element size with Sikasil SG-500
SG Joint Dimension: 12 mm x 6mm; wind load: 1.50 kPa; dead load supported

HIGH-STRENGTH PRODUCT

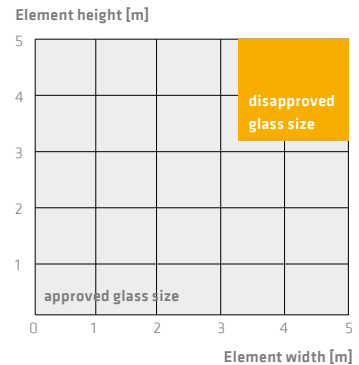
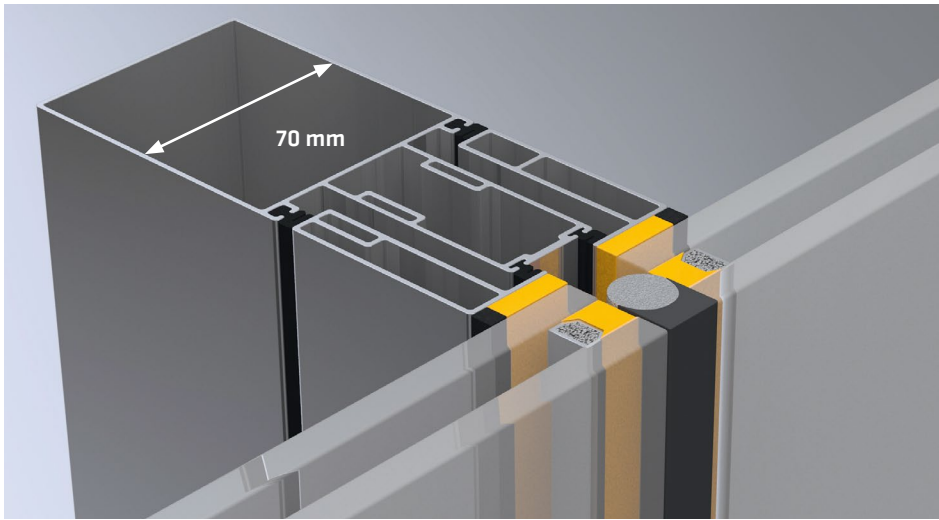

Fig. 11: Under the same conditions as in Fig. 10 the facade elements can be much bigger with Sikasil SG-550. Vice versa the joint bite for the same element sizes can be 30 % smaller and the total joint volume even 60 % lower



Sikasil® IG-25 HM Plus

High mechanical strength and design factors:

- Tensile strength: 1.4 N/mm²
- Design tensile strength σ_{dyn} : 0.19 N/mm²
- Design shear strength Γ_{∞} : 0.013 N/mm²

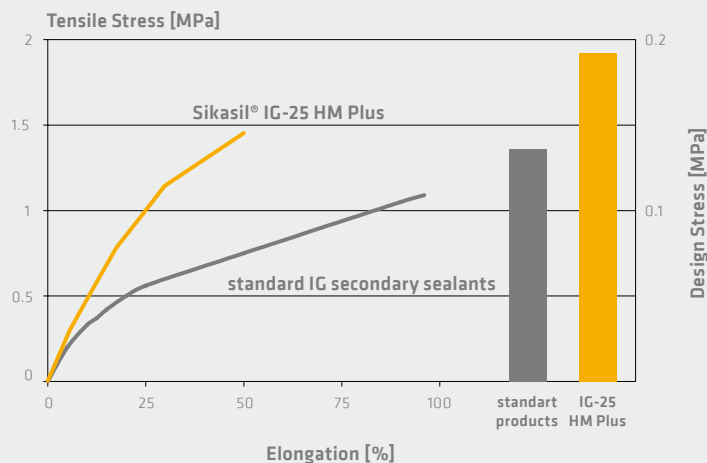

Fig. 9: Comparison of tensile stress and design strength of Sikasil® IG-25 HM Plus with standard IG products

MATERIAL SAVINGS IN ALL DETAILS

The higher strength of the adhesives has an enormous saving impact on the material consumptions:

For a project with a wind load of 5 kPa and glass dimensions of 1.6 x 3.5 m we have calculated the savings:

- SG joint: 60 %
- IG joint: 23 %
- Spacer tape: 55 %
- Aluminum: ~8 %

More details and sizes are visualised in the drawings above.

Let the sun shine in

Modern architecture is light and transparent. It requests filigree frames in light weight aluminum constructions for large airport and sports hall facades or widespanning glass roofs. In the schematic drawings above the aluminum aspects have been reduced by 25 %. The slimmer the frames the more transparent is the facade, the higher is the solar heat gain.

Sustainability all-over!

COLD-BENT GLAZING

IN THE LAST TWO DECADES the glass industry has learned a lot about the strength and the behavior of glass under various kinds of loads. As warped glass is very expensive and complicated to produce, gradually cold-bent glass units became a trend in structural glazing facades with minor curvature, challenging not only the glass units and metal frames but also the silicone adhesives. Therefore, Sika has investigated and tested beyond existing standards the properties and the behavior of Sikasil® SG adhesives under permanent tensile and shear stresses and deformations and has developed production and installation methods for curved facade units.

Basic Design and Production Concept (Method 1)

The production procedure of cold-bent facades units ideally consists of the following steps:

- The flat IG unit is positioned on spacer tapes or gaskets on the flat aluminum frame.
- The gap between glass and frame is filled in by Sikasil® SG structural silicone adhesive.
- After the full cure of the adhesive the bonded assembly is moved to site.
- On site, the out-of-plane displacement is imposed by cold-bending at one of the corners of the bonded assembly, to shape and install it.

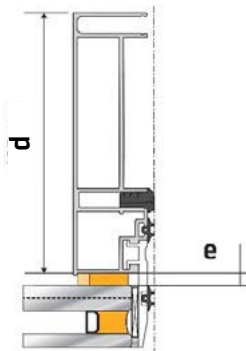

Fig. 12: Basic SG design. The bigger the depth d of the metal frame the higher the shear displacement of the SG joint, the bigger the min. SG joint thickness e required.

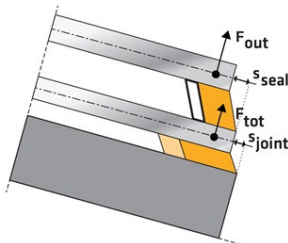

Fig. 13: Deflection of SG and IG joints under permanent tension and shear due to displacement and rotation after installation.

INITIAL CALCULATIONS

Calculation of joint bite h

$$h = \frac{4.5 PL}{(H+W)*\sigma}$$

σ	max. tensile stress on SSG joint due to cold bending
PL	dummy load to deform unit
H	glass height
W	glass width

Calculation of SG joint thickness e

1. Rotation of bonded components

$$\alpha \text{ [rad]} = 3.2 f / (2 L_{\min})$$

α [rad]	rotation of bonded components
f	max. displacement at corner imposed by cold bending
L_{\min}	length of shortest side of rectangular unit

2. Shear differential displacement s_{joint}

$$s_{\text{joint}} = \alpha (h_{s1-b} + h_{s2-b})$$

s_{joint}	differential displacement between glass and frame
h_{s1-b}	distance of barycentre of bonded section 1 (frame) to bonded area
h_{s2-b}	distance of barycentre of bonded section 2 (glass) to bonded area

3. SG joint thickness e

$$e = s_{\text{joint}} G / \tau_{\infty \text{Relax}}$$

e	thickness of the SG joint
G	adhesive shear modulus
$\tau_{\infty \text{Relax}}$	adhesive shear strength for permanent imposed displacement

The value of s_{joint} is obtained accepting that shear performance of Sikasil® SG is exploited above typical limits set by standards, considering adhesive relaxation phenomena under permanent and limited deformation.

These calculation can be supported by FEM analysis considering the isotropic hyperelastic material model for Sikasil® SG structural silicones. Consult Sika Technical Department Industry for help.

Joint Optimization by Frame Design (Method 2)

The cross-sectional depth d of the aluminum profile has a high influence on the magnitude of the differential shear displacement of the joint and on the thickness of the SG joint e.

Thus, reducing the depth of the bonded profile, due to design reasons, offers immediately the opportunity to significantly reduce the minimum SG joint thickness. If this is not possible due to static reasons inserting a slim freely gliding profile can help reducing the joint thickness to a reasonable dimension.

The procedure will then consist of the following steps:

- Bond the flat slim profile to the flat IG unit in factory and move the assembly on site when joints are fully cured.
- Install main load-bearing frame on the building structure.
- Cold-bend the assembly on site while fixing it mechanically to the main load-bearing frame.

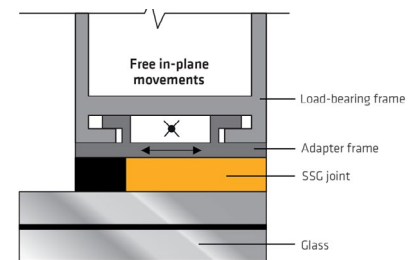

Fig. 14: Slim adapter frame, free to rotate and slid

Joint Optimization by Manufacturing Procedure (Method 3)

A very effective way to eliminate completely the permanent shear displacement in the SG joint due to cold-bending is using hot-bent frame members, so that only the flat IG unit needs to be cold bent. Independently from the cross-sectional depth of the frame profile, the glass unit can be cold-bent on the pre-shaped frame and temporarily fixed to it by mechanical devices; application of the SG joint can follow. After the adhesive has completely cured, mechanical devices can be removed. As result, tensile forces will stress the joints but introduction of permanent shear displacement due to cold bending will be prevented permanently. Only the flat IG unit needs to be cold bent.

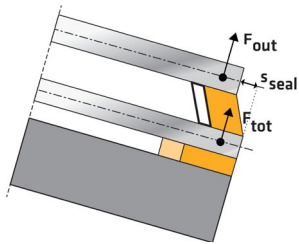

Fig. 15: Forces and deformed joints after the frame and the glass are shaped

Joint Optimization by Installation Procedure (Method 4)

The same effect as shown in Fig. 15 is achieved by a variation of the working procedure:

- Pre-bend the metal frame to the final curvature.
- Temporarily fix the IG unit to the bent frame with mechanical devices and apply the SG adhesive.
- After the SG joint is fully cured allow the element flip back and move it on site.
- Install the element on the building structure and bend it to the final curvature.

Important: Element can be in a deformed position for a maximum of 7 days.

Joint Optimization by Use of Mechanical Fixations (Method 5)

A further possibility is using permanent mechanical devices to restrain the glass unit to the frame (see Fig. 16), so that no permanent tensile forces and permanent shear displacement due to cold bending are transferred to the joints. However, the aesthetic impact on the final facade has to be considered.

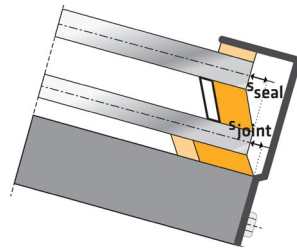
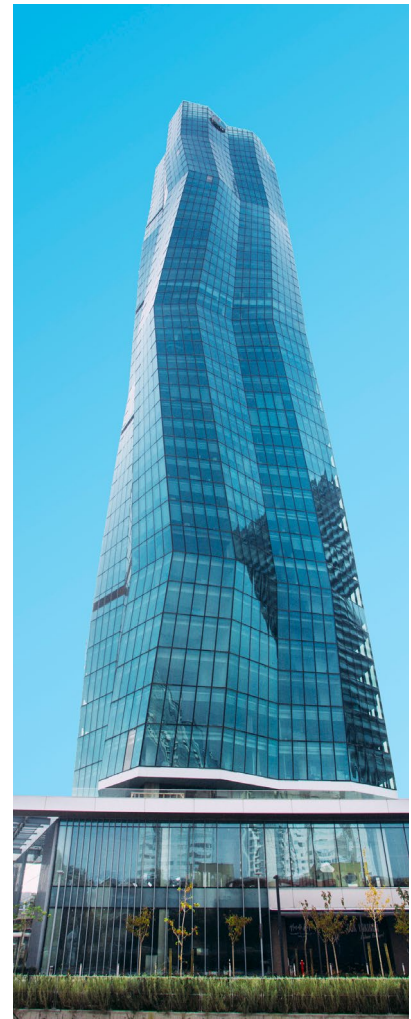

Fig. 16: Forces, displacements and deformed joints after the flat bonded assembly is cold bent and mechanical devices are used

Certainly a combination of the Methods 2 to 5 may further reduce the stress in the joints and thus the minimal joint dimensions.

The table below shows the impact of variations in design and manufacturing methods of cold-bent glass facades. Consult Sika Technical Department Industry for technical support.



Mistral Tower, Izmir, 2017
Architects Progetto CMR
Facade Acar Metal; Insulating Glass Kutas - Erdem

Production Method	Profile depth d [mm]	Minimum Joint dimensions [bite x thickness]	
		Wind load 2.5 kPa	Wind load 4.0 kPa
Method 1	185	>51 x 51 mm	N/A
Method 2	6	25 x 8 mm	28 x 10 mm
Method 3	185	18 x 8 mm	27 x 8 mm
Method 4	185	18 x 8 mm	27 x 8 mm
Methods 2 & 4 combined	6	21 x 7 mm	27 x 8 mm

Comparison of joint dimensions for cold bending glazing methods evaluated for Mistral Tower
Glass sizes: Approx. 1500 x 4000 mm, IG cavity: 16 mm.
Out-of-plane displacement: +/- 32 mm

INSULATING GLAZING

Keeps Energy Costs Low

THE FACADES are mainly responsible for the energy balance of a building. The excellent thermal insulating effect of bonded double or triple glazed units with coated glass can save much of the energy otherwise consumed for heating or cooling. The air trapped between the bonded panes is a poor heat conductor and therefore forms a good insulating layer between the outdoor and indoor air.

THERMAL INSULATION INCLUDED

The insulating glazing edge seals are predominantly made of bent aluminum or stainless steel spacers filled with a desiccant, thermoplastic polyisobutylene (PIB) as a primary seal and installation aid, and an elastic sealant as a secondary edge seal. Only high-modulus silicone is approved as a secondary seal in structural glazing facades. Sikasil® IG silicone sealants were specifically developed to meet requirements of insulating glazing and feature special advantages:

- **UV and weathering resistance**
- **Durability**
- **Material compatibility**

INTEGRATED SYSTEMS

In insulating glazing, double or triple glazing alike, it is particularly important that no water vapor should penetrate into the space between the panes, since it would condense as water on the cold pane. To avoid this during the whole service life of an IG unit, use a double-sealed edge seal system: see drawing on opposite page.

- Aluminum, stainless steel, or plastic spacers (C) ensure the necessary distance between panes (A).
- The desiccant (B) absorbs any moisture that penetrates through the edge seal.
- The polyisobutylene primary (D) seal serves as an installation aid, sealing against moisture and minimizing gas leakage in the case of insulating glazing units filled with noble gas (e.g. Argon, Krypton).
- The secondary edge sealant (E) bonds the panes together, provides the double glazing with mechanical stability, and is also a moisture barrier.

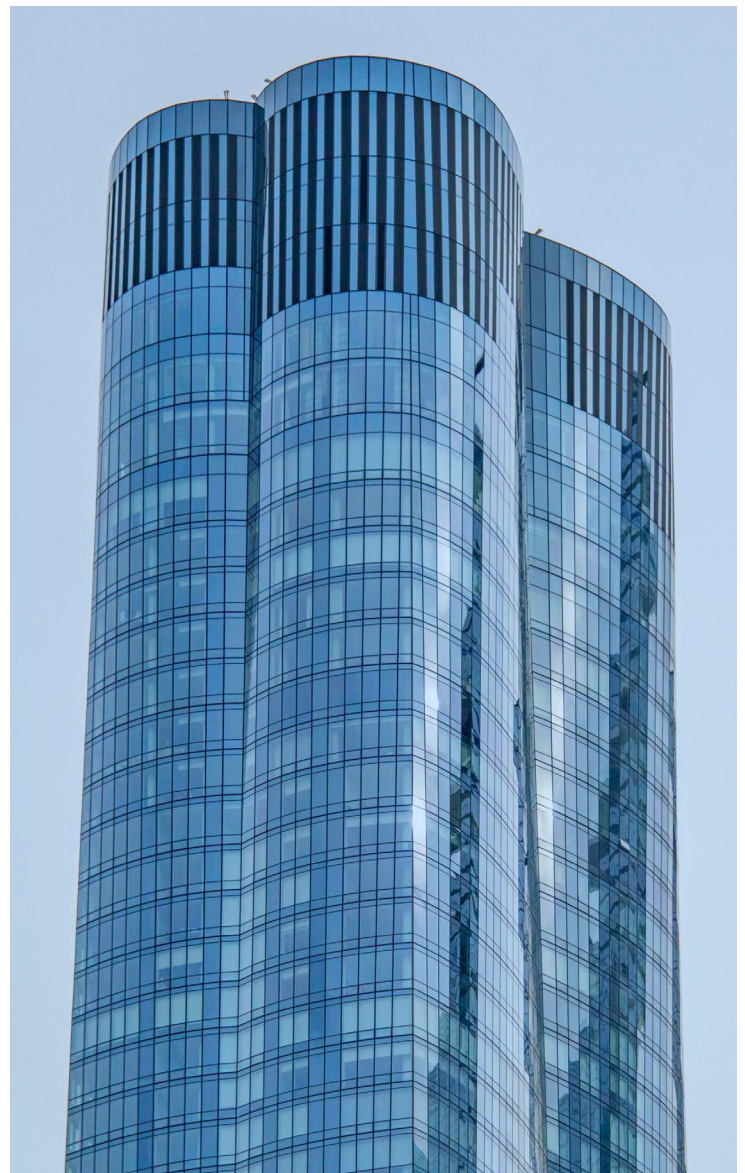

15 Hudson Yards, New York, 2019

Architects Diller Scofidio + Renfro; Insulating Glass Interpane Glasgesellschaft

DUAL SEAL INSULATING GLASS – THE PRINCIPLE

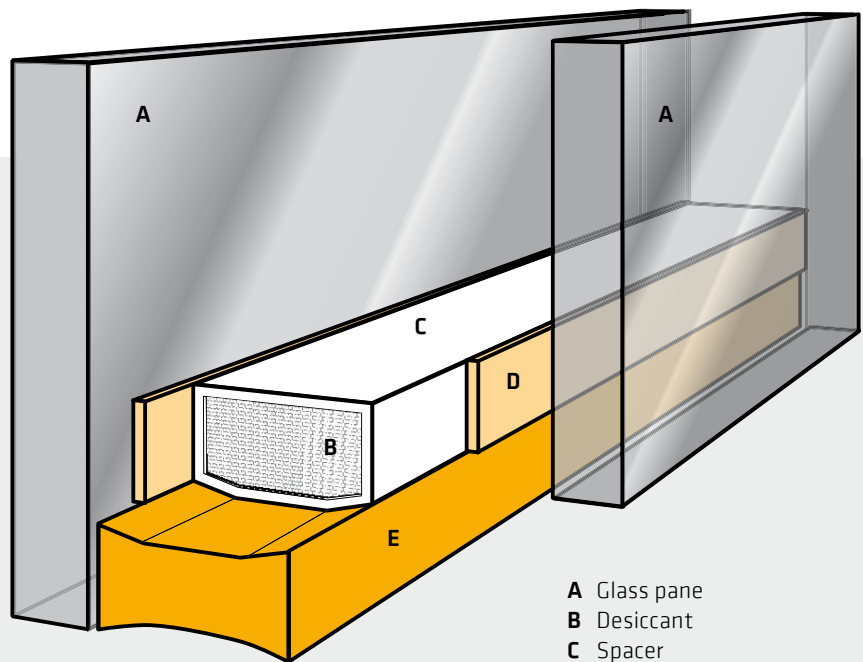

- A Glass pane
- B Desiccant
- C Spacer
- D Primary sealant
- E IG secondary edge seal



Hospital Rey Juan Carlos, Madrid, 2012
Architects Rafael De La-Hoz; Facade Permasteelisa Spain; Curved Glass Cricursa

Sikasil® IG SECONDARY SEALANTS

TAILORED PROPERTIES

The sealant is chosen according to the individual requirements of the insulating glazing unit. Sika offers Sikasil® IG silicone sealants for the secondary edge seals of insulating glazing units. These sealants are characterized not only by outstanding tooling and bonding characteristics, but also by unparalleled UV stability. This permits durable constructions with a uniformly high quality of workmanship.

Sikasil® IG-25 HM Plus

- Two-component silicone secondary edge seal
- For machine application
- Outstanding processing properties (dosing and tooling)
- Extremely high mechanical strength
- Very high design factor for slim edge sealing
- Excellent weathering and UV resistance
- Extremely high resistance to water and moisture
- Structural capabilities
- Suitable for most kinds of curtain wall insulating glazing units
- Complies with ETAG 002, EN 13022, EN 15434, EN 1279-2, -3, 4, ASTM C1184, C1369, E2190, CEKAL and ETA approved (ETA 11/0391), marked with CE

Sikasil® IG-16

- One-component secondary edge seal
- Neutral curing
- Ready to apply
- Outstanding tooling properties
- Excellent weathering and UV resistance
- Suitable for stepped double glazing units in curtain walls
- Complies with EN 1279-2, -3, -4

Sikasil® IG-25

- Two-component secondary edge seal
- For machine application
- Outstanding processing properties (dosing and tooling)
- High mechanical strength
- Structural capabilities
- Excellent weathering and UV resistance

- High resistance to water and moisture
- Suitable for most kinds of curtain wall double glazing units
- Complies with ASTM C1184, ASTM C1369, GB 16776-2005, ETAG 002, EN 15434, EN 1279-2, -4, CEKAL and ETA approved (ETA 05/0068), marked with CE and SNJF VI-VEC

Sikasil® IG-25 S

- Two-component secondary edge sealant
- For machine application
- Very good UV and weathering resistance
- Structural capabilities
- Adheres well to a wide range of substrates
- Good long term durability
- Meets requirements of GB 16776, ASTM C 1184 and ASTM C 1369

APPLICABLE STANDARDS

The test requirements laid down in international standards are designed to ensure an acceptable service life of the insulating glazing unit used in a facade. The climatic test usually includes cyclic conditioning of small double glazing units and subsequent testing of vapor permeability (dew point temperature).

The most important standards are: EN1279 (2018), Glass in building – insulating glass units

- Part 1, generalities, tolerances, system descriptions
- Part 2, moisture vapor penetration
- Part 3, inert gas leakage rates
- Part 4, physical attributes of edge seals
- Part 5, evaluation of conformity
- Part 6, factory production control

EN13022 (2014/2015) and EN15434 (2021): Standards for insulating glazing in SG curtain walls.

The most important ASTM standards are:

- ASTM C1369-19: Standard Specification for Secondary Edge Sealants for Structurally Glazed Insulating Glass Units
- ASTM C1249-18: Standard Guide for Secondary Seal for Sealed Insulating Glass Units for Structural Sealant Glazing Applications
- ASTM E2188-19: Standard Test Method for Insulating Glass Unit Performance
- ASTM E2190-19: Standard Specification for Insulating Glass Unit Performance and Evaluation

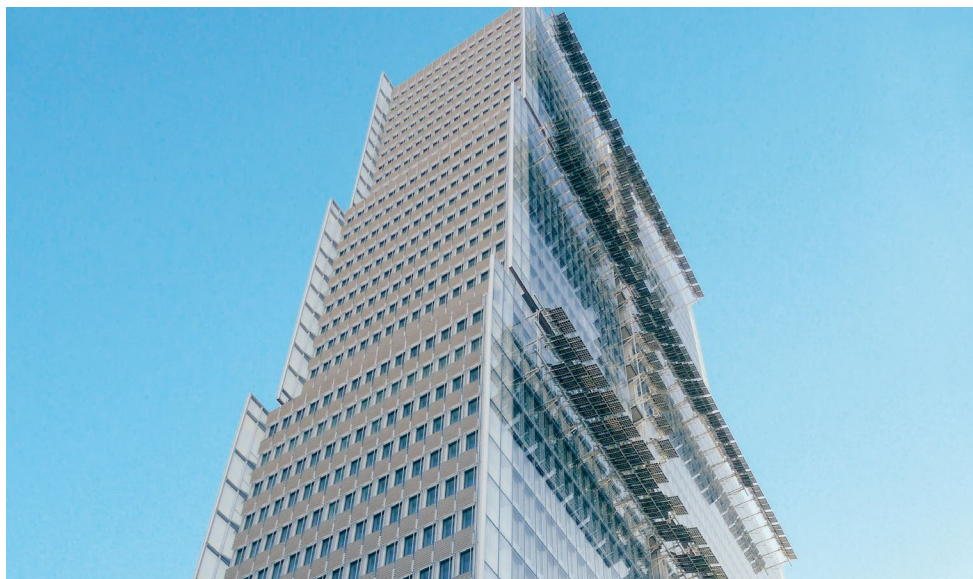

Palais De Justice De Paris, Paris, 2017

Architects Renzo Piano Building Workshop; Facade Permasteelisa SpA

Sikasil® IG-25 HM Plus

ENERGY-SAVING WITH INERT GAS FILLING

Besides glass coatings the gap-filling with inert gas is one means of reducing heat losses. With an argon-filled cavity the U-value of an IG unit can be reduced by $0.3 \text{ W/m}^2\text{K}$. This means an oil saving potential of up to 3 litres per year per square meter of glass facade and even 4 times more energy equivalents for cooling in hot climates. For big glass facades this not only means a high potential of energy saving but also a tremendous reduction of carbon dioxide and hence the greenhouse effect.

The high argon diffusion rate of the silicones has been the obstacle to the use in argon-filled IG units. Bending movements of the glass panes due to changes of temperature and atmospheric pressure and the non-elastic behavior of PIB cause leakage of the

primary seal and thus cause high gas loss rates in IG units sealed with silicone. With the development of the high-modulus IG secondary edge seal Sikasil® IG-25 HM Plus the glass panes in IG units are very tightly held together. Movements in the butyl layers, caused by temperature and pressure changes, are minimised. As a consequence leakages in the butyl primary seal, the main barriers against argon penetration, are prevented. As the PIB layer in fact is the argon barrier, comprehensive application know-how and quality control during the IG production are crucial. For the stability requested in SG facades, these IG units can be produced with rigid boxshaped spacer bars (aluminum or stainless steel).

ENERGY SAVING FOR MORE THAN 30 YEARS – SUSTAINABILITY ALL-OVER

An argon content of 80 % can be expected in the IG cavity after 30 years, considering the average argon loss rate of 0.5%/year obtained in the tests complying with the European standard for argon-filled IG units (EN 1279-3). Even after 30 years, the energy transfer coefficient of an IG unit (U_g value) should have increased only by less than $0.1 \text{ W/m}^2\text{K}$. This means that for the whole service life of a glass facade the high energy performance of the argon-filled insulating glass units remains almost unchanged.

For details of Insulating Glass see:
www.sika.com/ffi-ig

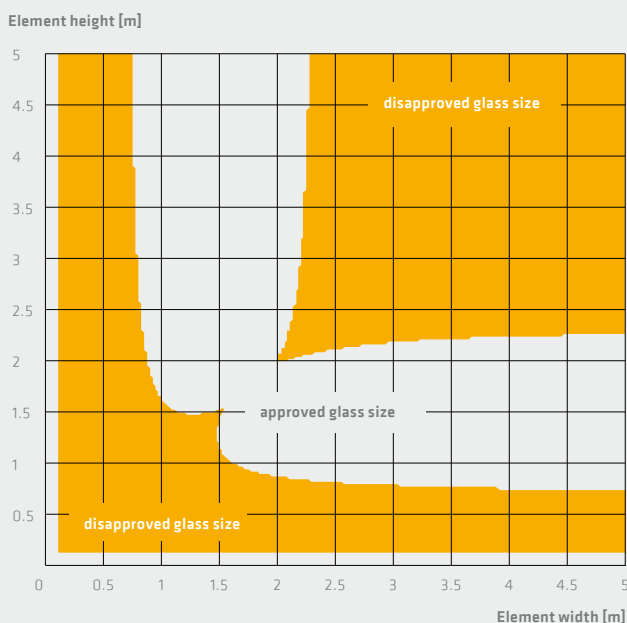

Fig. 17: Feasible triple glazed IG unit with Sikasil® IG-25, IG configuration 8/10/4/10/8
 IG Joint dimensions 10 mm x 6 mm

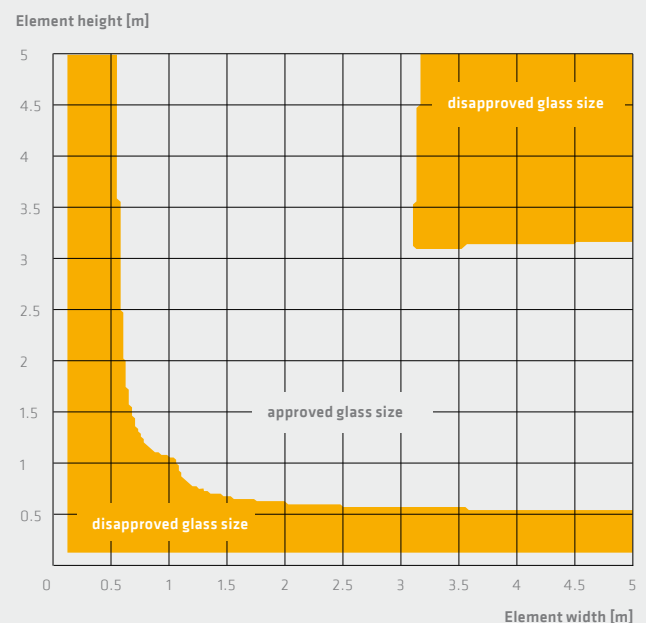

Fig. 18: Under the same conditions as in Fig. 17, the IG units can be much bigger with Sikasil® IG-25 HM Plus. Vice versa the seal height for the same unit sizes can be 25 % smaller.

SEAL HEIGHT CALCULATION

CALCULATION OF JOINT DIMENSIONS IN STEPPED CONFIGURATIONS

The IG seal height r is calculated solely by taking into account the environmental loads when the smaller inside pane is supported by setting blocks. It is advisable to have the seal height checked by one of our FFI Competence Center. The seal height r should be at least 6 mm, but must be calculated according to the loads acting on the system.

NON-STEPPED (SYMMETRICAL) DOUBLE GLAZING UNITS

In the case of double glazing units in mechanically supported structural glazing constructions, the outer glass pane is held onto the frame by means of the secondary edge seal. The minimum seal height r is calculated for two cases A and B (see formulas below).

SUPPORT FROM OUR SIKA FFI COMPETENCE CENTERS

For precise and reliable calculations of seal height please contact your Sika FFI Competence Center. For standard situations calculate your joint dimensions with the Sika Joint calculator.

www.sika.com/ffi-joint-calculator



IMPORTANT

SG adhesive bonding of an unsupported IG unit is not recommended because of excessively high stress in the IG secondary edge seal. If inevitable you should contact the FFI Competence Center in Switzerland.

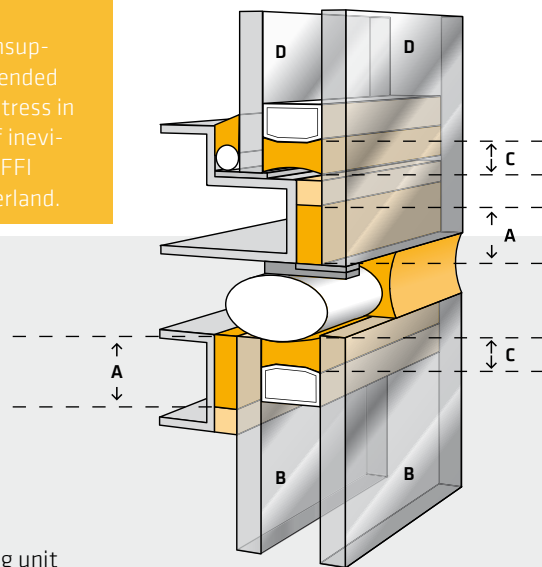

SEAL HEIGHT CALCULATION IN IG UNITS

- A** SG joint bite h
- B** Symmetrical double glazing unit
- C** IG seal height r
- D** Stepped double glazing unit

Simple calculation of the seal height in symmetric configurations according to EOTA ETAG 002-2004

A) When the thickness of the outer glass pane > thickness of the inner glass pane:

$$r = \frac{a \times w}{2 \times \sigma_{dyn}}$$

B) When the thickness of the outer glass pane < thickness of the inner glass pane:

$$r = \frac{a \times w}{4 \times \sigma_{dyn}}$$

STEPPED DOUBLE GLAZING UNIT

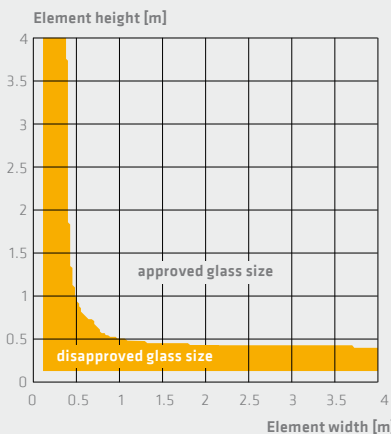

Fig. 19 Only climatic loads are relevant for sealant height calculation

SYMMETRICAL DOUBLE GLAZING UNIT

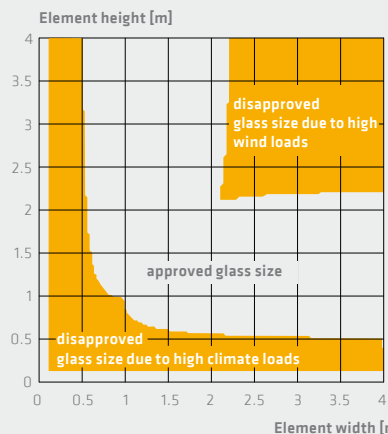

Fig. 20 Climatic and wind loads are relevant for sealant height calculation

r height of the insulating glass secondary seal [mm]
 a length of the shortest side of the glass [mm]
 w maximum expected wind load [MPa]
 σ_{dyn} design value of dynamic tensile strength [MPa]
 For design values of Sikasil® IG products see page 54.

EFFECT OF ENVIRONMENTAL LOADS

Especially for small glass panes and non-standard formats, there are 4 steps to consider for a precise calculation of the IG sealant height:

1. Calculation of isochoric Pressure p_0

The isochoric pressure is the pressure caused by climatic loads such as the max. estimated difference of temperature ΔT , atmospheric pressure Δp_{atm} and the difference in altitude ΔH between the production site of the IG unit and its installation site.

2. Estimation of Glass Deflection

Based on the value of p_0 the deflection of the glass panes is calculated by various methods (e.g. Plate method or Timoschenko method). The deflection is influenced by the pane thickness and their size. Small, thick panes require big seal heights (e.g. IGU 0.75 x 0.75 m: minimum seal height of 18 mm).

3. Real internal Pressure

The increase of the cavity volume by the glass deflection reduces the isochoric

pressure to the real internal pressure. The pump action caused by environmental loads is shown in the illustrations in Fig 25.

4. Total Load on the secondary Seal

The sum of the climatic load of point 3 and the wind load results in the final load on the IG edge seal.

$$p_0 = (\Delta T \times 0.34 \text{ kPa/K}) + \Delta p_{atm} + (\Delta H \times 0.012 \text{ kPa/m})$$

INFLUENCE OF GLASS THICKNESS ON SEAL HEIGHT

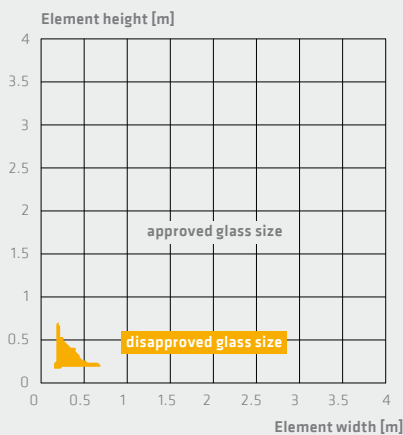

Fig. 21 Residential fenestration
Glass: 4/12/4 mm, p_0 : 12 kPa
Seal height: 6 mm

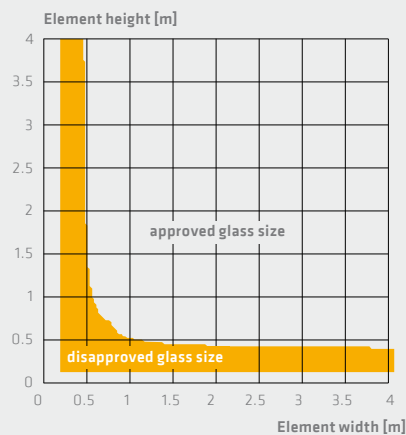

Fig. 22 Commercial glazing in high-rise buildings
Glass: 6/12/6 mm, p_0 : 20 kPa
Seal height: 6 mm

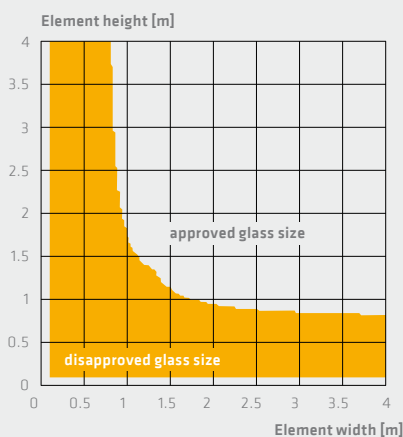

Fig. 23 Protective glazing
Glass: 10/12/8 + 8 mm, p_0 : 20 kPa
Seal height: 6 mm

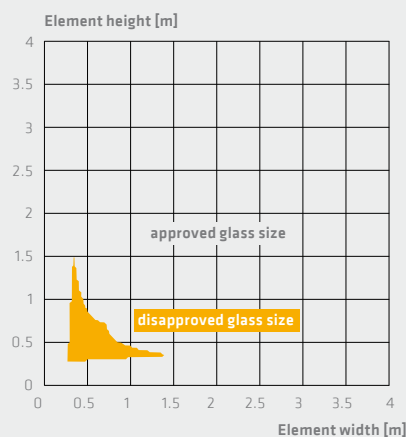
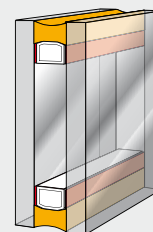
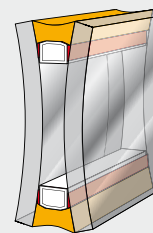

Fig. 24 Protective glazing, increase of seal height
Glass: 10/12/8 + 8 mm, p_0 : 20 kPa
Seal height: 18 mm with IG-25
Alternatively 13 mm with IG-25 HM Plus

Fig. 25 Glass deflection due to climatic loads



Standard external influences



High atmospheric pressure, low temperature

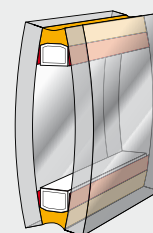

Low atmospheric pressure, high temperature

PROTECTION AGAINST THE ELEMENTS

Sikasil® WS WEATHERSEALS

QUALITY AND OPTICAL appearance of a curtain wall are critically dependent on appropriate weather sealing. The individual units are ultimately subject to extreme movements due to temperature changes, moisture (in the case of concrete), shrinkage of construction materials (wood, concrete), sound, wind and vibrations, which may affect the joints and adjacent elements.

PERFECT APPEARANCE

The joints between the elements may be effectively sealed with preformed gaskets or alternatively with UV and weather resistant silicone sealants. Sikasil® WS silicone sealants preserve the quality and perfect optical appearance of the facade in the long term, thanks to their outstanding advantages:

- UV and weathering resistance
- Improved impermeability to air and driving rain
- Very good movement absorption

DIMENSIONING OF WEATHERPROOFING JOINTS

In general

- The joint edges must run parallel to a depth of twice the joint width, but at least 30 mm. This gives the backing material sufficient grip.
- For most sealants, the joint width must be at least 4 times the expected joint movement, which results from 25 % movement capability
- The optimal ratio of joint width to depth is 2:1

PROJECT-SPECIFIC ADHESION TESTS

For weather-tight sealing of a curtain wall, it is essential to ensure optimum adhesion of the sealant to the surfaces. Before the sealant is used, it should therefore be individually tested for perfect adhesion to specimens of the project material at Sika's FFI Competence Center.

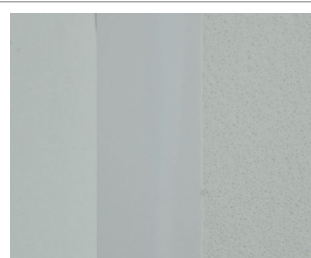

PERFECT COLOR MATCHING IN GREY S6 FROM LEFT TO RIGHT

- Polyisobutylene (PIB)
- Sikasil® SG, IG, WS
- Sika® Spacer Tape HD

WEATHERSEALANTS FOR GLASS AND METAL FACADES

Sikasil® WS-305

- Ready-to-apply one-component sealant
- Neutral curing
- UV and weathering resistant
- Highly flexible
- Complies with ASTM C920 class 50, TT-S-001543 A, TT-S-00230 C, EN 15651-1, -2 (F EXT-INT CC 25LM, G CC 25 LM), CE marked

Sikasil® WS-605 S

- Ready-to-apply one-component sealant
- Neutral curing
- Non-streaking on glass and metal surfaces, reduces facade cleaning cost
- UV and weathering resistant
- Highly flexible
- Complies with ASTM C920 class 50, TT-S-001543 A, TT-S-00230, ASTM C1248 C, ISO 11600 F-G 25 LM, DIN 18540, DIN 18545, EN 15651-1, -2 (F EXT-INT CC 25LM, G CC 25LM), marked with CE, SNJF, AENOR, ATG

Sikasil® WS-200

- Ready-to-apply one-component sealant
- Neutral curing
- UV and weathering resistant
- Highly flexible
- Available in translucent
- Complies with ASTM C920 class 25, ISO 11600 F 25 LM & G 25 LM, EN 15651-1 F EXT-INT 25LM, EN 15651-2 G CC 25LM (CE-marked), AENOR Marca N F+G 25 LM, SNJF Facade & Vitrage 25 E

INDIVIDUAL COLOR SCHEME

For weatherseals and natural stone sealants, Sika offers project-specific color matching services. In addition to the wide range of standard colors (see color samples on page 57), Sika also offers individual special colors on request. Please note that special colors are subject to special delivery conditions such as minimum order quantities and delivery times. Your Sika sales manager will be pleased to give you further details.

WATER/VAPOR PROOFING MEMBRANES

Connections of the glass facade to the concrete structure can be too wide for wet sealing. For sound water proofing Sika offers sophisticated vapor control membrane systems (see page 38).

WEATHERPROOFING GASKETS

UV-resistant silicone rubber gaskets are suitable for use as structural glazing weatherseals. All gaskets (particularly non-silicones such as EPDM) have to be individually tested for compatibility according to ASTM C1087 or EOTA ETAG No. 002.

STANDARDS AND GUIDELINES

Because of the requirements for the sealant, standards for weatherseals are significantly different from those for structural glazing applications.

ISO 11600 is the world's first standard to combine the classification of widely different sealant grades and their tests. However, national standards, such as ASTM C920 and DIN 18545 are also important, not only because of local practices, but also because of specific characteristics such as the abrasion test (DIN 18545) or early movement capability (DIN 18540).

In Europe, sealants must be tested against EN 15651, parts 1-4 and CE marked.

- part 1 - Sealants for facade elements
- part 2 - Sealants for glazing
- part 3 - Sealants for sanitary joints
- part 4 - Sealants for pedestrian walkways

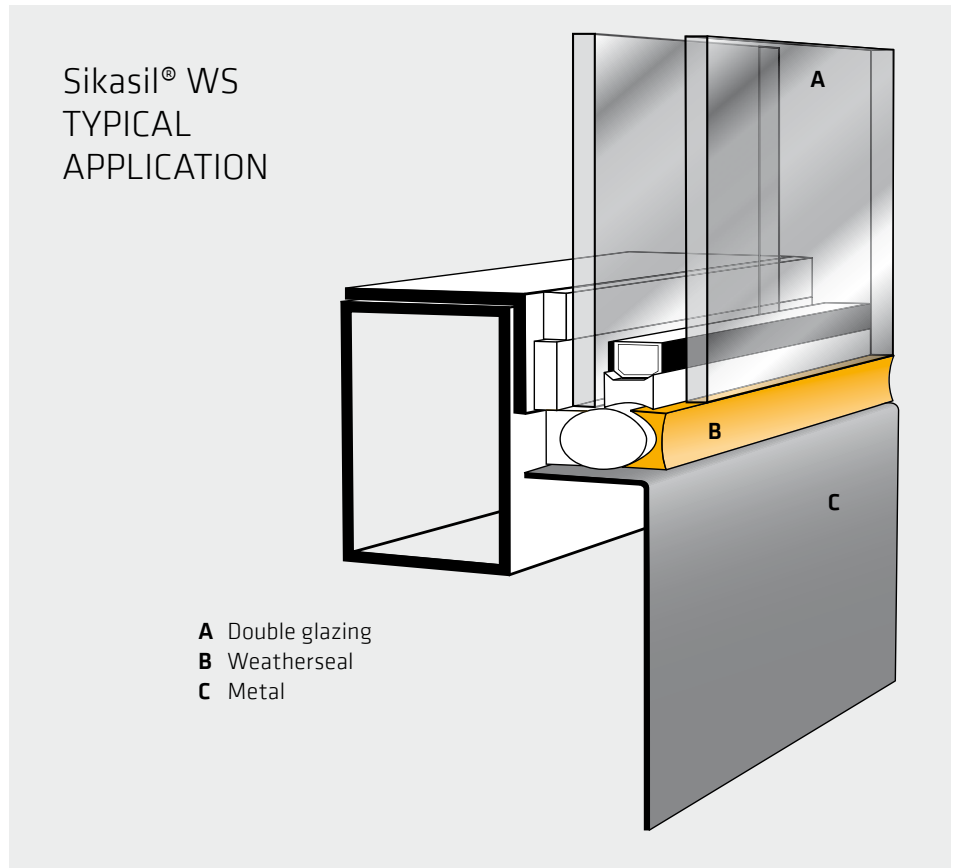

Republic Polytechnic Center, Singapore, 2006
Architects Fumihiko Maki, DP Architects; Sealed with Sikasil® WS-605 S, after >10 years no signs of streaking effect

Joint movement in tension

$$e \geq \Delta a / c$$

Joint movement in shear

$$e \geq \frac{\Delta b}{\sqrt{2c + c^2}}$$

Minimum joint depth (h) = 6 mm
Maximum joint depth (h) = 15 mm.
Optimum joint ratio width (e) : depth (h) between 2:1 and 4:1.

e joint width [mm]
 Δa elongation or compression in tension [mm]
 Δb expected shear movement [mm]
c movement capability of weather sealant
e.g. c = 0.25 means $\pm 25\%$ movement capability

Example 1:
Elongation and compression is 5 mm.
Movement capability is $\pm 25\%$
 $e = 5 / 0.25 = 20$ mm

Example 2:
Shear movement is 15 mm.
Movement capability is $\pm 25\%$
 $e = 15 / (\sqrt{2 * 0.25 + 0.25^2}) = 20$ mm

NATURAL STONE SEALING

SEALANTS SUITABLE FOR NATURAL STONES

Natural stones such as granite, marble and sandstone are highly sensitive materials when used on facades. Where an inappropriate sealant is used, there may be staining of the joint edges or streaking, which greatly impairs the optical appearance of the facade. Sika therefore recommends special system-compatible Sikasil® WS silicone sealants ideally suited for use with extremely sensitive natural stone elements, or for connecting metal facades and curtain walls to natural stone elements.

These sealants contain no staining compounds that could migrate into the pores of the natural stone. We therefore describe them as non-staining. These non-staining silicone sealants are also recommended for glass facades in order to reduce streaking on glass panes and metal panels and to minimize the need to clean the facade.

SYSTEM-COMPATIBLE PRIMERS

Use Sika® Primer-210 or Sika® Primer-3 N to ensure long-term adhesion to stones of all types. Exact instructions for applying primer and sealant are given in our application guidelines.

APPLICABLE STANDARDS

The worldwide most frequently quoted standard for non-staining sealants is ASTM C1248-18: Standard Test Method for Staining of Porous Substrates

For details of Weather Sealing see:
www.sika.com/ffi-ws



Sikasil® WS-355 N

- Weatherseal for natural stone facades
- Ready-to-use one-component sealant
- Neutral curing
- No staining on natural stone
- UV and weathering resistant
- Highly flexible
- Complies with ASTM C920 class 50, ASTM C1248 C

Sikasil® WS-605 S

- Ready-to-apply one-component sealant
- Neutral curing
- No staining on porous substrates
- UV and weathering resistant
- Highly flexible
- Complies with ASTM C920 class 50, TT-S-001543 A, TT-S-00230, ASTM C1248 C, ISO 11600 F-G 25 LM, DIN 18540, DIN 18545, EN 15651-1, -2 (F EXT-INT CC 25LM, G CC 25LM), marked with CE, SNJF, AENOR, ATG



Pangu Plaza, Beijing, 2008
Architects C.Y. Lee & Partners Architects & Planners
Facade Shanghai Huayi

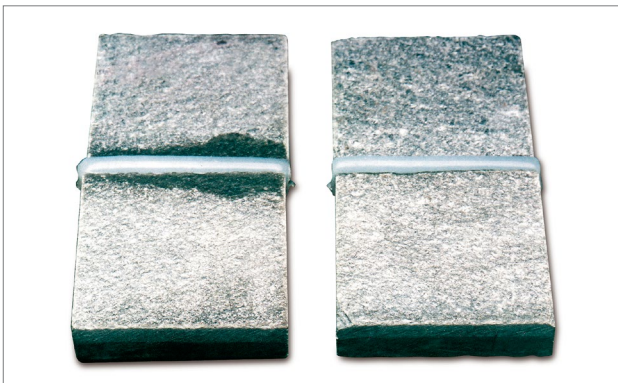
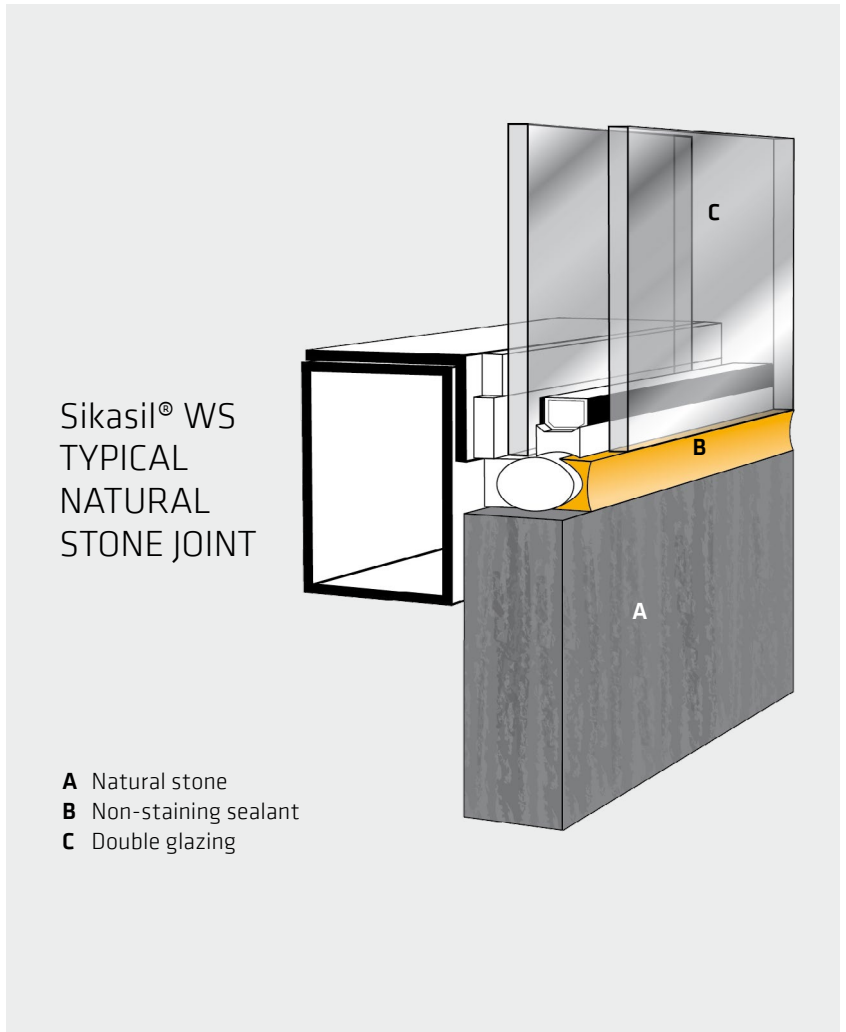

Using the wrong sealants causes staining of natural stone elements (see left specimen).

The specimen on the right has been sealed with Sikasil® WS-355 N and exposed for 4 weeks to 70 °C / 158 °F under 50 % compression.

IMPORTANT

Since all natural stones are very sensitive materials, a non-staining test shall be carried out at our FFI Competence Centers before any natural stone sealing operation. This is an essential precondition for non-staining guarantee.

FIRE-RATED SEALING

FIRE-RATED SEALING

Many casualties have been reported in serious fire catastrophes, not only because of fire but also of smoke poisoning. The integrity of the joints is crucial and gives fire brigades a chance to rescue people. Sika offers 4 hours fire-rated sealants both for vertical joints in facades and for horizontal floor joints between the facade and the floor slabs.

Sikasil®-670 Fire

- Weatherseal for fireproof facades
- Ready-to-use one-component sealant
- Neutral curing
- Non-sagging
- UV and weathering resistant
- Highly flexible
- Tested against BS476, part 20: 4 hours fire-rated
- UL Listed, tested against UL2079: 2 hours fire-rated
- Classified DIN 4102, B1
- Complies with EN 15651-1 (F EXT-INT CC 25LM), CE marked

- Classified DIN 4102, B1
- Complies with EN 15651-4 (PW INT 25LM), CE marked

STANDARDS AND GUIDELINES

A wide variety of local standards and guidelines have become established worldwide. The most important are:

In Europe

- EN 13501, parts 1-5, Fire classification of construction products and building elements
- BS 476, part 20: Fire resistance tests

In the USA

- UL 94: Flammability Tests of Materials
- UL 1479: Fire Tests of Through-Penetration Firestops
- UL 2079: Tests for Fire Resistance of Building Joint Systems

Sikasil® FS-665 SL

- Fire-rated, self-leveling sealant for horizontal joints
- Ready-to-use one-component sealant
- Neutral curing
- Self-leveling
- UV and weathering resistant
- Highly flexible
- Tested against BS476, part 20: 4 hours fire-rated

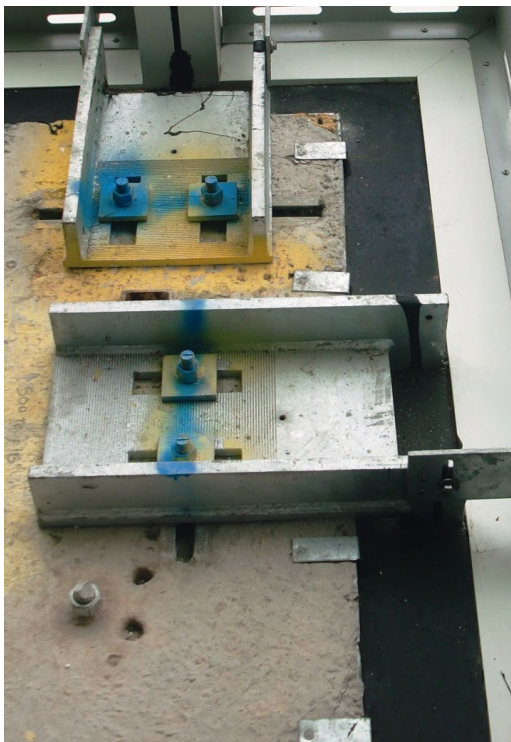

Application of Sikasil® FS-665 SL

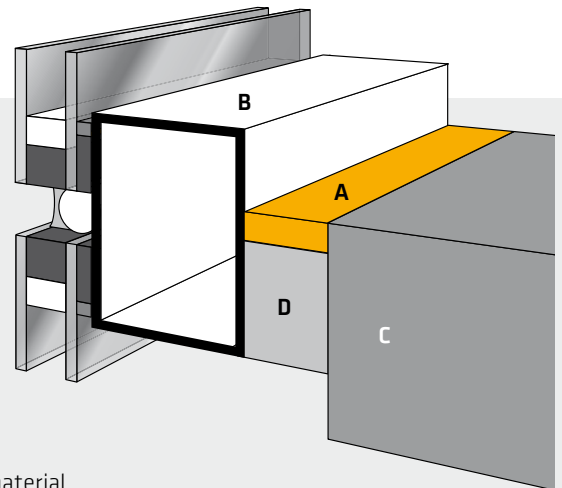

Sikasil® FS FLOOR JOINT APPLICATION

- A Sikasil® FS-665 SL
- B Facade profile
- C Floor slab
- D Fire retardant insulation material

	Sikasil®-670 Fire	Sikasil® FS-665 SL
Components	one-component	one-component, self-leveling
Curing system	neutral	neutral
Skin forming time ¹⁾ [min]	~ 25	~ 50
Permanently elastic range ²⁾ [°C]	-40 to +150	-40 to +150
Shore A hardness ²⁾	~ 20	~ 15
Tensile strength ³⁾ [N/mm ²]	~ 0.6	~ 0.8
Modulus at 100 % elongation ³⁾ [N/mm ²]	~ 0.3	~ 0.3

1) @ 23 °C/50 % rel. humidity, 2) ISO 868, 3) ISO 8339-A.

These figures are intended as a guide and should not be used in preparing specifications.

For technical information about the products, please ask for the latest respective data sheets.

PRETREATMENT AGENTS

For complete Structural Glazing and Weather Sealing

SYSTEM-ORIENTED EXECUTION

Perfect structural glazing execution requires careful coordination of details. Sika therefore offers a wide range of pretreatment agents for preparing substrates and processing sealants. These products integrate into the whole facade product system and are carefully matched to Sikasil® silicone sealants. They will round off your structural glazing job.

PRETREATMENT FOR OPTIMUM ADHESION

Thorough cleaning of the glass and metal surfaces is essential for reliable bonding of the Sikasil®SG and Sikasil® WS silicones. Therefore Sika supplies special products with optimized adhesion to a wide variety of materials. Our FFI Competence Centers will carry out thorough tests on the project materials to determine the best primer to use on the metal frame employed. Based on our experience and the test results, we will make specific product

recommendations for each structural glazing project. Clear float glass does not usually need to be primed where Sikasil® silicone products are used.

	Application
Sika® Cleaner P	Cleaner for all types of plastics and powder-coated metals
Sika® Cleaner G+M	Cleaner for highly contaminated glass and anodised aluminum
Sika® Aktivator-100	Cleaner/activator for anodized aluminum and enamelled glass
Sika® Aktivator-205	Cleaner/activator for anodized aluminum, stainless steel and many powder coatings
Sika® Primer-210	Primer for porous, vitreous surfaces
Sika® Primer-790	Primer for organic coatings (PVDF, PPC)
Sika® Mixer Cleaner	Cleaner for two-component mixing machine



PERFECT VAPOR PROOFING IN ALL CLIMATES

SikaMembran® SYSTEM



Park View Green Plaza, Beijing, 2010
Consultant ARUP Hong Kong; Facade Beijing Jianli (CN)



5 Aldermanbury Square, London, 2005
Architects Eric Parry Architects; Facade Lindner-Schmidlin UK

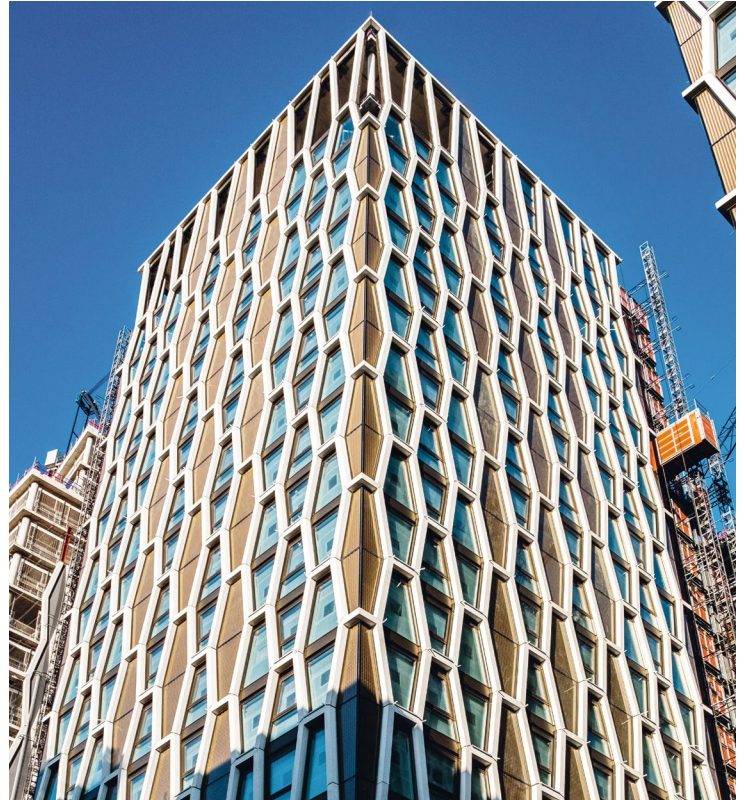

The Broadway London, 2021
Architects Squire & Partner; Facade Focchi Spa

MEMBRANE APPLICATION EXAMPLES

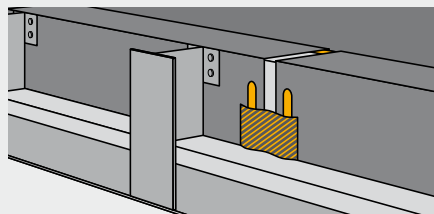

In ventilated facades SikaMembran® provides an adequate vapor control barrier throughout the whole year's climatic conditions. Water vapor must not be trapped in the structure.

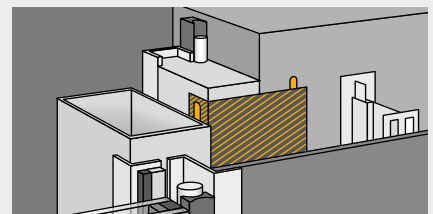

For wide gaps between the curtain wall and concrete structure SikaMembran® is the best solution.

WATER VAPOR IN BUILDINGS

Along with wind-driven rain, water vapor alone can also become a major problem in the structural framework. If the air is cooled to below the dew point, the excess moisture condenses as liquid water within the structure.

A “moisture transport mechanism” of this kind, where water migrates through structural members in the form of vapor, is particularly common in climates like that of Western and Central Europe and other similar climatic regions in the winter months. There is more water vapor in the atmosphere of heated rooms than in the outside air, and their concentration difference is balanced by vapor diffusion from the inside to the outside. This phenomenon is obviously reversed in tropical regions with a hot, damp climate outside but with cool, airconditioned rooms inside.

According to the Standard EN 13984 “Flexible Sheets For Waterproofing - Plastic And Rubber Vapour Control Layers - Definitions And Characteristics”, a structural element must be designed to prevent any condensed water inside the structure; for instance when water vapor diffuses from inside to outside and comes in contact with a material with a very high vapor diffusion resistance and/or a layer of thermal insulation.

As a rule of thumb, the equivalent air layer thickness (s_d value) of the colder side should be smaller than the s_d value of the warmer side. The vapor diffusion resistance of SikaMembran®

Universal has been optimized in a way that under most climatic conditions it can be used on both sides.

Membranes can be combined with wet seal on one side. For calculating the s_d value of the joints or membranes use following formula:

$$S_d = \mu \times d$$

- μ diffusion resistance coefficient
- μ (polyurethane): 2500
- μ (silicone): 1000
- μ (membrane): see table below
- d joint depth or membrane thickness

For further support ask your Sika FFI Competence Center.

SYSTEM SOLUTIONS

With SikaMembran® system solutions, facades can be protected effectively and fully in line with their requirements, both for curtain walling in glass and for concrete structures.

A secure connection to the structural formwork, yielding durable waterproofing of the joints, is obtained by the quick and easy bonding of the membranes between the envelope fabric and the structure, with the very tolerant and efficient elastic adhesive SikaBond® TF-Plus R.

For technical details and a video about vapor control in facades follow this link:
www.sika.com/ffi-membrane



Adia Building, Abu Dhabi, 2006
Architects Kohn Pedersen Fox Associates PC
Facade Schmidlin AG

	SikaMembran® Outdoor plus	SikaMembran® Outdoor	SikaMembran® Universal	SikaMembran® Strong
Thickness [mm]	0.6	0.6	0.6	1.2
μ -value	5 000	75 000	102 000	66 000
s_d value [m]	3	45	62	79
System adhesives	SikaBond® TF-Plus R			
Standard widths of 25 m rolls [cm]	10/15/20/25/30/35/40/45/50/140 (other widths are available on request)			
Main applications	Joints between structure and incorporated units, e.g. facade elements, windows, etc. Connecting joints in concrete and brick constructions in ventilated facades			
Approvals	All products comply with EN 13984 (CE marked) and meet fire retardant requirements of EN 13501-1 Class E (under free suspension)			

These figures are intended as a guide and should not be used in preparing specifications.
For technical information about the products, please ask for the latest respective data sheets.

RAIN SCREEN CLADDING WITH ELEGANCE

SikaTack®-Panel SYSTEM

RAINSCREEN CLADDING

Rain can be forced through the joints and openings of a typical building facade through the action of wind or via external and internal pressure differences. Ventilated rainscreen cladding overcomes these potential problems by utilizing the phenomenon of pressure equalization. The principle of pressure equalization offered by a rainscreen cladding system ensures the weather tightness of the building structure by eliminating the methods of which rain may enter the facade.

Rainscreen cladding is a tried and tested concept backed up with many years' experience in the development of relatively easily installed lightweight systems that are currently available. The main benefits of a fully integrated rainscreen cladding system for both new build and refurbishment include:

- Aesthetic improvement of the building facade with a wide choice of external finishes available
- Building structure protected from weathering yet remaining vapor permeable
- Increased thermal performance
- Extremely cost-effective
- Ease of construction with none of the inconvenience associated with 'wet' render trades

For details of Panel Bonding see www.sika.com/ffi-panel



Sika Joint calculator: www.sika.com/ffi-joint-calculator



THE SikaTack®-Panel STRUCTURAL FIXING SYSTEM

With SikaTack®-Panel adhesive system cladding finishes can be fixed to a carrier frame and allows the designer the freedom to design facades without any unsightly fixings. The permanent elastic nature of our SikaTack®-Panel adhesive system combined with a tenacious adhesion to a variety of panel substrate types accommodates the natural differential movements of varying building materials for the life of most panel types. This ingenious and simple system offers both the designer and installer alike many advantages over comparable rigid mechanical secret fixing systems. SikaTack®-Panel adhesive system is suitable for the fixing of composites, ceramic, high pressure laminate, cement based cladding panels as well as most metal and powder coated substrates.

Besides appropriate surface pretreatment agents SikaTack®-Panel system comprises of SikaTack®-Panel adhesives and SikaTack®-Panel fixing tape. The double sided adhesive tape is used for the temporary support for cladding panels while the SikaTack®-Panel adhesive cures. SikaTack®-Panel adhesive is moisture-curing single component polyurethane resin based adhesive, capable of withstanding extreme dynamic loads and climatic conditions. Alternatively SikaTack®-Panel-50 adhesive, a moisture-curing single component silicone adhesive, can be used. Once cured the adhesive remains permanently elastic to accommodate differing thermal expansion of various building substrates. It eliminates stress fatigue at corners of panels and prevents cold bridging.

For calculations of the glue line, depending on the weight of panels, maximal wind load and temperature difference, please contact your Sika FFI Competence Center or use our Sika Joint Calculator.

SikaTack® Panel

- Polyurethane panel bonding adhesive
- 1-part product, ready-to-apply
- Uniform tension over the whole facade
- Withstands very high dynamic and static stresses
- Approved from Spanish DAU 19/114 A

SikaTack® Panel-10

- Polyurethane panel bonding adhesive
- 1-part product, ready-to-apply
- Uniform tension over the whole facade

SikaTack® Panel-50

- Silicone panel bonding adhesive
- 1-part product, ready-to-apply
- Uniform tension over the whole facade
- Withstands high dynamic and static stresses and elevated facade temperatures, e.g. in metal facades
- Outstanding UV and weathering resistance

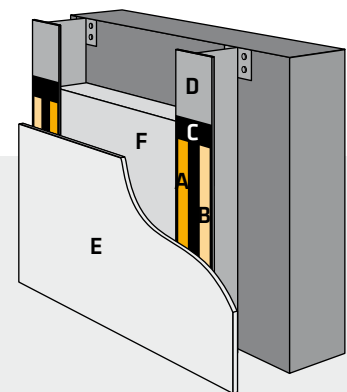

- A SikaTack® Panel Adhesive
SikaTack® Panel-50
SikaTack® Panel-10
- B SikaTack® Panel Prefixing Tape
- C SikaTack® Panel Primer
- D Aluminum Rail System
- E Facade Panel
- F Insulation Material
(e.g. mineral wool)



Sony Ericsson Head Office, Anstey Park, Coventry, United Kingdom

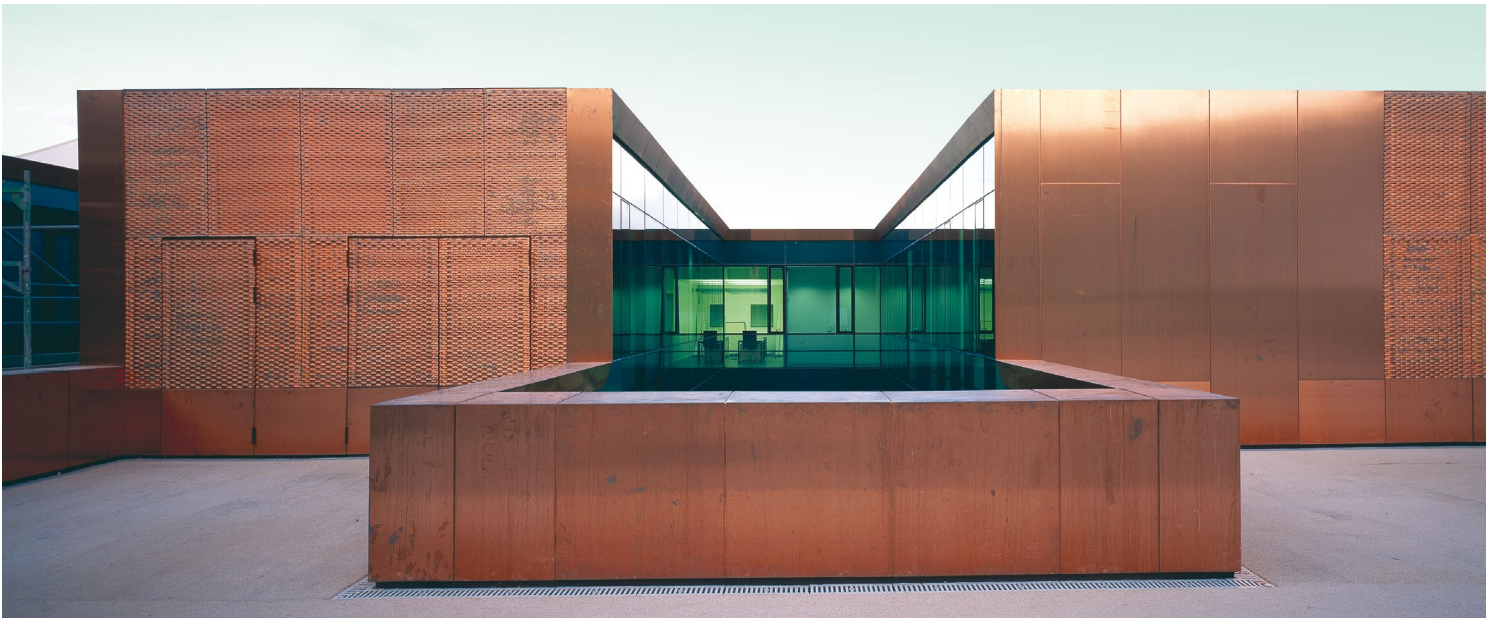

WIS Service Center, Theresienwiese, Munich, Germany



High Wycombe Campus @
Buckinghamshire New University,
United Kingdom

NOISE REDUCTION IN PANEL WALLS

SikaDamp® and Sikagard®

With the SikaDamp® and Sikagard® product range Sika transfers a well acknowledged noise reduction technology from the car and ship industry to construction sites and provides an easy-to-apply solution to reduce structure-borne vibrations or external impacts (rain drops and hail grains) on thin metal and composite panels in curtain wall spandrel areas or fully clad rainscreen walls (see page 40).

As the acoustic performance of a building depends on a lot of factors the product characteristics cover only one small aspect. The whole building acoustic very often is subject to mock-up measurements. For details consult experienced building physicists.

Relevant standards about acoustics:
ISO 140 part 1 - 18: Acoustics – Measurement of sound insulation in buildings and of building elements

BS 8233:2014 Guidance on sound insulation and noise reduction for buildings

SikaDamp®-600 series

SikaDamp® elastomer rolls or sheets are equipped with a thin aluminum flashing and can be easily cut into any customized shape and size. They are firmly rolled on the substrates and demonstrate excellent adhesion to many metal substrates, e.g. galvanized steel, and many organic panel coatings and composite materials. Their outstanding adhesive performance allows it to keep the position in demanding vertical and inverted applications, even at elevated temperatures up to 90 °C / 194 °F. SikaDamp® elastomers maintain their acoustic and adhesive properties after subjection to the various accelerated aging and weathering test conditions.

- SikaDamp®-610 is mainly used in Asia Pacific.
- SikaDamp®-620 is mainly used in Europe and Middle East.
- SikaDamp®-630 is mainly used in the Americas.

For the sizes of rolls and sheets please ask your local Sika contact.

Sikagard®-6682

Sikagard®-6682 is an easy-to-use waterbased acrylic dispersion for airless spraying in the paint shop. In a coating layer of 2 mm thickness it shows a sound damping performance comparable to a 1 mm thick SikaDamp® sheet (see Fig. 27).

SikaDamp®
Sikagard®
TYPICAL
APPLICATION
IN CLADDING
WALLS

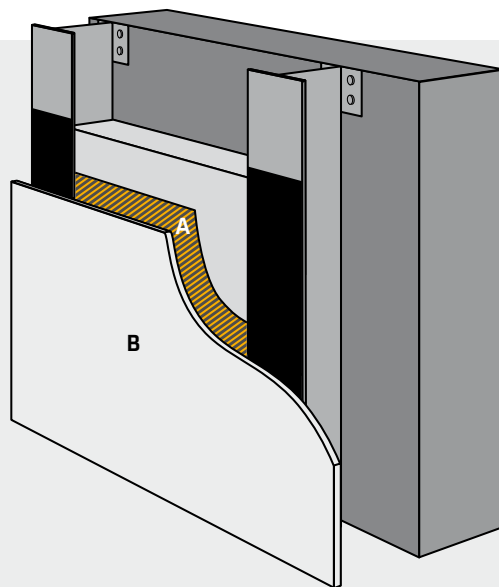

- A** SikaDamp® Sound Damping Sheet
- B** Metal or composite panel

VIBRATION-DAMPING PROPERTIES (ASTM E756)

Loss factor Beam 200 [Hz]

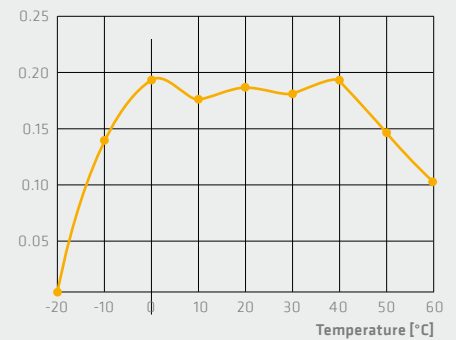

Fig. 26 SikaDamp®-620 demonstrates its sound reduction performance over a wide range of frequencies even up to 20 dB.

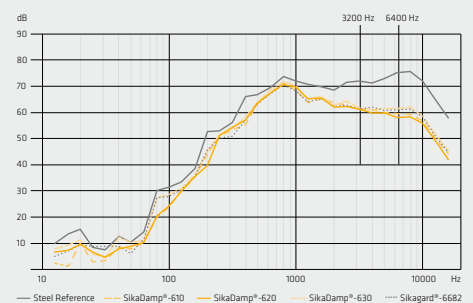

Fig. 27 Impact Noise Reduction on Steel Panel: All SikaDamp® and Sikagard® products show very similar performance, in both frequency ranges relevant for architectural acoustics (100 - 3200 Hz) and room acoustics (100 - 6400 Hz).



Office Building Zurich West, Zurich, 2013
 Facade Yuanda Europe

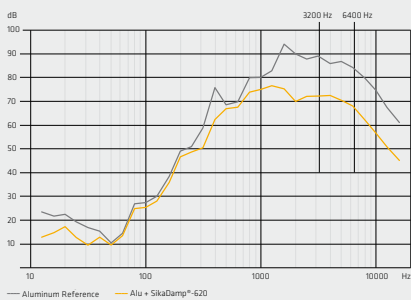

Fig. 28 Impact Noise Reduction of SikaDamp®-620 on Aluminum Panel: very efficient already at frequencies below 3200 Hz, important for building acoustics, but also below 6400 Hz in room acoustics. A decrease of 20 db means a sound reduction by 75 %.

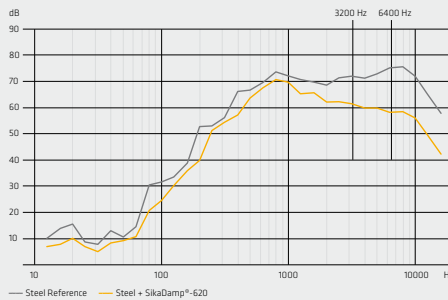

Fig. 29 Impact Noise Reduction of SikaDamp®-620 on Stainless Steel Panel: most efficient sound damping in room acoustics below 6400 Hz, in building acoustics below 3200 Hz a reduction by more than 50 % is still achievable.

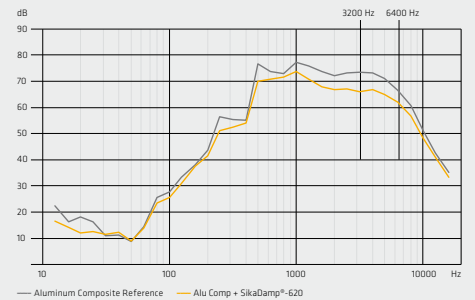

Fig. 30 Impact Noise Reduction of SikaDamp®-620 on Aluminum Composite Panel: even with already sound-dampened Composite Panels a reduction by up to 7 dB is still achievable below 3400 Hz.

STRESS-FREE GLASS EMBEDDING

SikaForce® GG GLASS GROUT



MahaNakhon, Bangkok, 2016
Architects Buro Ole Scheeren; Balustrade Peterson

Glass balustrades should be fixed to the floor with the lowest possible stress to the glass pane, but mechanical fixings transfer high punctual stress to the glass, leading to thicker panes.

An easy-to-apply solution is the embedding of the bottom glass edge in the floor with self-leveling, high-strength fast-curing 2-part PU system SikaForce®-335 GG, resulting in uniform stress distribution and an enormous reduction of punctual stresses. For a fast, self-leveling application a gap of 10 mm on each glass side is required, leading to a minimum consumption of 2.5 liter per running meter glass balustrade.

SikaForce®-335 GG is compatible with many grades of interlayers (e.g. PVB, Ionomers) avoiding delamination, discoloration and glass cracks. In outdoor applications the PU grout shall be protected against weathering with a Sikasil® WS weather sealant.

TESTED AGAINST GERMAN TRAV REGULATION

SikaForce®-335 GG has been tested by the Laboratory for Steel and Light Metal Construction, Munich, for accident proofing based on the Technical Regulations for the use of accident-proof glazing (German abbr. TRAV) and carries a German General Building Authority Test Report. The approval covers a set-up made of two 10 mm tempered or heat strengthened safety glass panes with 1.52 mm PVB interlayer. The clamping depth of the glass pane was 100 mm. The U-channel was made of 10 mm steel and totally rigid in order to test worst case scenario. Impact tests were carried out with a pendulum according to DIN EN 12600 with a dropping height of 700 mm.

For details of embedding glass balustrades see www.sika.com/ffi-glass-grout



SikaForce® GG TYPICAL APPLICATIONS

- A SikaForce® GG Glass Grout
- B Sikasil® WS weather sealant
- C Glass balustrade
- D U channel (metal or concrete)

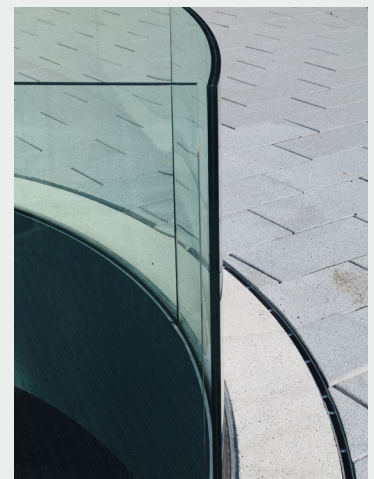
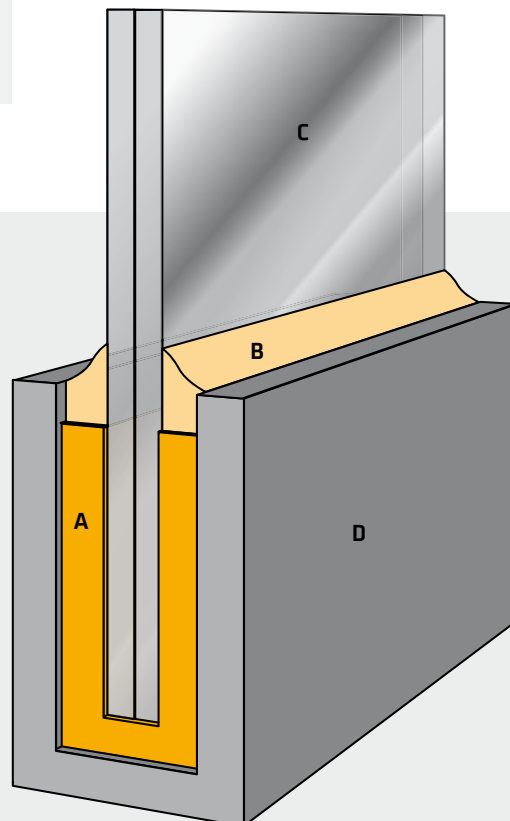

Fast and stress-free embedding of curved balustrades

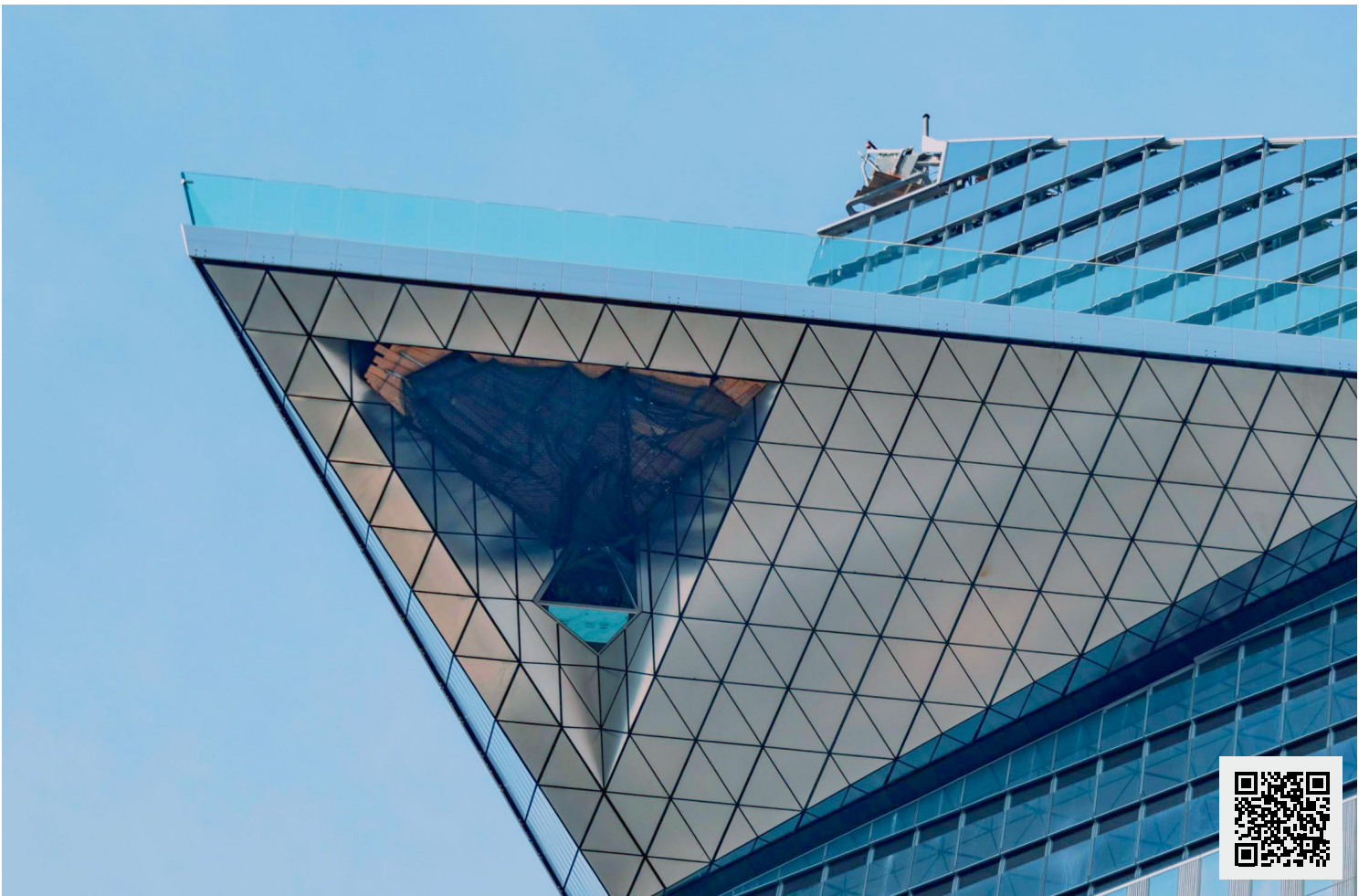

Observation Desk at 30 Hudson Yards Tower, New York, 2019
Architects Kohn Pedersen Fox Associates; Balustrades CS Facade

Riverbank House, London, 2011
Architects David Walker Architects; Facade and balustrades Josef Gartner (DE)



BONDING EXCELLENCE

Safety by Knowledge



TECHNICAL SUPPORT FOR OUR CUSTOMERS HAS ALWAYS BEEN A HIGH PRIORITY AT SIKA. Driven by the use of new materials, stricter building regulations and an increasing decoupling of planning and execution in the globalized economy, our customers are finding that ensuring consistent delivery of complex projects in the construction industry is becoming increasingly challenging.

Sika responds to the ever growing complexity in the construction industry with the BONDING EXCELLENCE quality program. It is not enough for us just to deliver our reliable and certified products. We also want to provide tools that enable our partners using Sika products in a professional way. Training and securing knowledge is an essential pillar for a successful project realization. The BONDING EXCELLENCE quality program covers the various, sometimes-delicate project workflow management aspects of adhesive bond design, verification and implementation on a structurally bonded facade. BONDING EXCELLENCE consists of several elements:

- Training of customers in various aspects of the proper storage, preparation and application of Sika products.
 - Support in the setup of in-house quality control at customers for bonding applications.
 - Availability of advanced technical support in questions relating to bonding applications.
 - The provision of an online project workflow management tool.
- In this way, a complex project from planning to implementation in a cross-company team is supported by a structured project workflow.

BENEFITS

- Efficiency gain in handling of structurally glazed facade projects
- Lean management of your facade project with the BONDING EXCELLENCE portal
- Comprehensive technical training for your applicators
- Increased quality awareness in your teams
- Trustworthy safety of your finished glass and facade products
- Driving a new professional standard for structural glass facades

WHEN A PROFESSIONAL USER OF SIKA PRODUCTS ALWAYS DOES MORE THAN WE EXPECT, ISN'T IT FAIR THAT HE CAN EXPECT MORE RETURN FROM SIKA? THAT'S WHAT WE BELIEVE AND AS A RESPONSE, SIKA HAS CREATED TWO DIFFERENT PROGRAM QUALIFICATION LEVELS THAT MAKE OUR CUSTOMERS EVEN MORE PROFESSIONAL IN THEIR FACADE PROJECTS.

BASIC LEVEL: TRAINED APPLICATOR

Trained applicators are trained by Sika in the use and application of Sika products. During live training sessions, the important aspects of successful bonding are trained such as surface pre-treatment, correct product application and quality control scheme. Deglazing audits by Sika are performed on request on a project base.

TOP LEVEL: BONDING EXCELLENCE PLATINUM CONTRACTOR

In order to become a BONDING EXCELLENCE PLATINUM CONTRACTOR, facade contractor and insulating glass fabricator alike, a program participant must have shown continuity over several years in terms of quality management and business relation with Sika. The BONDING EXCELLENCE program charter requires a facade contractor or insulating glass fabricator to commit to consistent quality management along all steps of the adhesive bonding process. As part of the renewal of BONDING EXCELLENCE program participation, Sika performs a factory audit of the entire application process of Sika's products at the program participant. The scope of the audit is defined in the audit checklist and available to BONDING EXCELLENCE program participants at www.sika-bonding-excellence.com.

A BONDING EXCELLENCE PLATINUM CONTRACTOR will benefit from advanced technical service and extended warranties by Sika. And finally, we are proud to promote our BONDING EXCELLENCE PLATINUM CONTRACTORS to specifiers and investors.

SIKA FFI COMPETENCE CENTERS

Global FCC

- Switzerland

Regional Technical Centers

- Brazil
- China
- Dubai
- Germany
- Romania
- USA

These FFI Competence Centers will support our customers throughout the project from project tests to application training and deglazing tests.

STRUCTURAL GLAZING PROJECT



INDUSTRY STANDARDS AND EXPERTISE

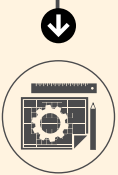

Design Assessment

- Sika Engineering Experts
- Correct joint dimensions
 - Drawing review



Laboratory Test

- Sika Competence Centers
- Adhesion tests on substrates
 - Compatibility tests with adjacent materials
 - Material and product assessment
 - Sika laboratory report

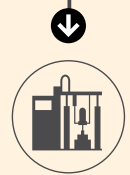

Application

- Sika Application Trainers
- Correct product application
 - Quality control scheme
 - Trained Applicator Certificate

Project Platform: www.sika-bonding-excellence.com

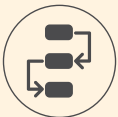

Project Workflow



Cross Company Teams

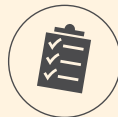

Task Assignment



Project Documentation and Literature



Sika Joint Calculator

SYSTEMATIC PROJECT WORKFLOW

DETAILED PROJECT STAGES

Individual project testing is carried out according to a reliable and practicable system, which forms a solid basis for successful project execution. For an effective, up-to-date project tracking Sika has developed the advanced online platform www.sika-bonding-excellence.com with a quick and easy-to-use visualisation of the progress of each step of the project workflow.

Note: Detailed information and descriptions of the practical activities, such as cleaning and priming the surfaces or applying the sealants, can be found in the “structural glazing application guidelines”. The forms used for the various stages are available from our homepage www.sika.com/facade.

IMPORTANT

The samples sent to Sika for project tests (adhesion and compatibility tests like) must be representative for the materials used in the building project. Materials must not be exchanged during the project without notifying Sika.

	Action	Form	Performed by
Design Phase			
Step 1	Project manager (customer) or responsible Sika persons upload all relevant design details (drawings - including bonding situation) and project details (wind loads, max. temperatures, glass/panel sizes) to Sika Project Platform for inspection.	Project Creation Mask and Design Request Mask or Project Information Form	Customer
Step 2	Sika performs following items: <ul style="list-style-type: none"> - checks joint details - checks joint dimensions - assesses the materials used - recommends the correct sealant for these applications based on all the details known <p>Customers may use the Sika Joint Calculator for standard joint calculations, e.g. for plain and non-sloped elements.</p>	Sika Joint Calculator and/or Drawing Review Report	Sika or Customer Sika
Test Phase			
Step 3	Customer describes all substrates and ancillary materials and sends them to Sika for testing. The number and sizes of the samples are given on the online platform and in the leaflet “Sample Submittal Information”.	Test Request Mask or Sample Submittal Information	Customer
Step 4	Sika conducts the following tests: <ul style="list-style-type: none"> - Adhesion tests to all substrates (glass, facade panels and frame materials). - Compatibility tests with all materials (according to customer information) that our adhesives and sealants come into contact with. - Based on the results, Sika makes recommendations for cleaning and, if necessary, priming the surfaces. The results and recommendations are summarized in a laboratory report. <p>A guarantee can only be given if all submitted samples are compatible and the adhesion is sufficient.</p>	Lab report	Sika
Application Phase			
Step 5	Sika instructs the applicator on all matters of the applications: <ul style="list-style-type: none"> - Adhesive application - Quality control during application - Help with machine application - Sika also helps with the correct application of its products (e.g. weather-sealing) on site. After successful instruction, the customer receives a training certificate from Sika. 	Training Certificate	Sika
Step 6	The customer applies the Sika products as instructed and diligently carries out the recommended quality controls during processing. The quality control is documented on the appropriate forms.	QC logbook	Customer
Step 7	Sika performs Deglazing Audits of bonded facade elements after complete cure.	Deglazing Audit Report	Sika
Guarantee Phase			
Step 8	Once application of the products is complete, the customer uploads all QC documents from step 6 and 7 to the Sika Project Platform for inspection.		Customer
Step 9	Sika provides a limited guarantee on Sika products. For guarantee templates and further details, please check out the Sika Project Platform or ask your local Sika contact.		Sika

PROJECT TESTS

ADHESION AND COMPATIBILITY TESTS

Adhesion tests according to national and international guidelines and standards, and our own test methods ensure perfect adhesion of our products to the substrates used in any one project. We also test the compatibility of all materials that come into contact with Sikasil® silicone sealants and adhesives. Only compatible materials ensure that there is no negative effect on either the adhesion behavior or the mechanical properties of the silicone adhesives. The results are provided as a report. We use the results obtained to make recommendations on surface treatment, e.g. cleaning and priming, of the substrates used.

	Duration of Tests, incl. Report
One-component sealants Sikasil® WS and adhesive sealants Sikasil® SG and IG	
Adhesion tests with sealant bead	33 days
Compatibility test - discoloration CQP593-8	33 days
Compatibility test - mechanical properties CQP593-4 / 1	56 days
Non-staining test	115 days
Two-component adhesive sealants Sikasil® SG and IG	
Sikasil® WS Weather Sealants	
Adhesion tests with sealant bead	33 days
Compatibility test - discoloration CQP593-8	33 days
Compatibility test - mechanical properties CQP593-4 / 1	56 days

TRIPLE-TESTED PRODUCT QUALITY

1. Sealant Tests According to Standards and Guidelines

Silicone adhesives used for structural glazing must withstand extreme demands on their load-bearing capacity and durability. Sika offers one- and two-component systems that conform to the European guideline for bonded glass structures (EOTA ETAG No. 002). The specified tests include, for example, UV/water immersion at 45 °C / 113 °F for 1000 h and exposure to NaCl/moisture and SO₂/moisture. They also comply with American standards ASTM C920 and C1135, and Chinese standard GB 16776.

2. Quality Control in Silicone Sealant Production

As a company certified to ISO 9001 and ISO 14001, Sika has developed a quality control system that identifies any deficiencies at the production stage, and guarantees that only perfect goods leave the plant. As a prerequisite for the CE marking, Sika's facade silicone production in Europe is regularly supervised by external auditing institutions.

3. Quality Control in Sealant Application

For every project, it is essential that the customer should carry out factory production controls, with evidence of the mechanical strength and adhesion to various substrates (see table below). Precise details on the tests can be found in our "structural glazing application guidelines". Sika service laboratories advise customers as to how to perform best these controls and train staff. All QC test specimens must be kept for the full guarantee term.

Sika provides a lab case with all the equipment for the proper quality control during the application of Sikasil® IG and Sikasil® SG adhesives requested by international or local standards. Please ask your Sika contact for details.



Lab case for quality control during application of Sikasil® SG and Sikasil® IG adhesives

IMPORTANT

Sikasil® SG adhesives shall only be used for structural projects if Sika has first given written approval for the particular project.

RECOMMENDED QUALITY CONTROL DURING STRUCTURAL BONDING

1- component Sikasil® SG-18, SG-20

Skin forming time
Tack-free time

Adhesion test on original materials
(glass, support frame)

Measurement of Shore A hardness

Mechanical properties on H-test
specimens according to ISO 8339

2- component Sikasil® SG-500, SG-500 CN, SG-550

Visual control of the mixing quality
(butterfly test or marble test)

Quantitative check of the mixing ratio
by weight

Pot life

Adhesion test on original materials
(glass, support frame)

Measurement of Shore A hardness

Mechanical properties on H-test
specimens according to ISO 8339

2-component Sikasil® IG

Visual control of the mixing quality
(butterfly test or marble test)

Quantitative check of the mixing ratio
by weight

Pot life

Adhesion test on original materials
(glass coatings, edge-deleted glass, spacer bars)

Book Test

Measurement of Shore A hardness

Mechanical properties on H-test
specimens according to ISO 8339 or ASTM C1135

SUPPORT BEYOND STANDARDS

DESIGN PHASE

FINITE ELEMENT CALCULATIONS

Joint design becomes more complex, joint sizes get smaller and smaller, loads and movements go to extremes.

Our specialists in the FFI Competence Center in Switzerland accompany trends and developments not only with sophisticated tests but also with the latest methods of finite element calculations, both on whole building details, such as the cold bent glass element on the right, and on adhesive joints scrutinizing them for peak stresses with hyperelastic modeling shown below.

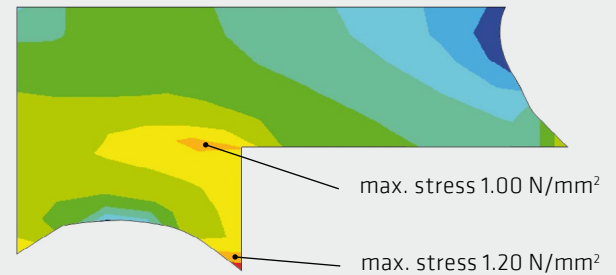
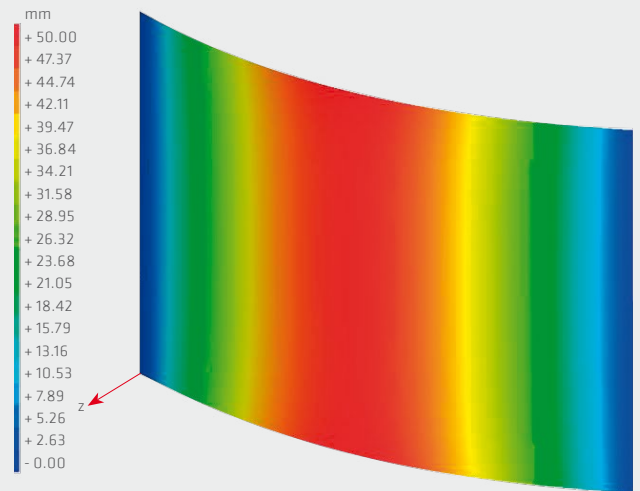
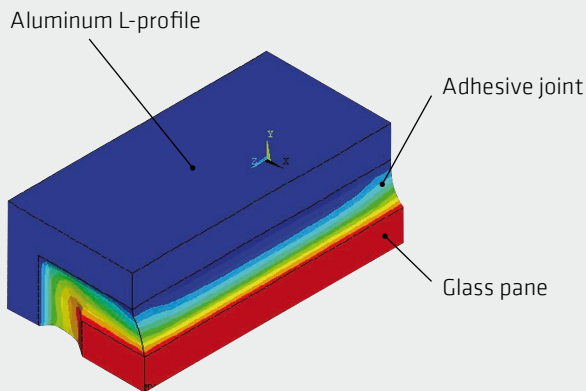

For more details explore our Guideline about "Finite Element Modelling of Sikasil® SG and Sikasil® IG Adhesives for Structural Silicone Glazing" on www.sika.com/facade



TEST PHASE

With more than 30 years experience in curtain wall industry and structural glazing applications in particular Sika puts enormous efforts in adhesion and compatibility tests before the project start. Regardless of any complexity of test specimens or extreme climatic conditions in the test chambers or even long test durations exceeding standard test methods. This can even mean the development of suitable test regimes for completely new applications..



APPLICATION PHASE

Sika Technical Service teams are located around the world, and are dedicated to providing best practice selection, validation and application of Sika materials. By being located close to our customers, Sika's application service provides fast and reliable support throughout the technical application development process to ensure the best possible results - from product development (top left) to small scale manual application (bottom left) to automated series production (right).

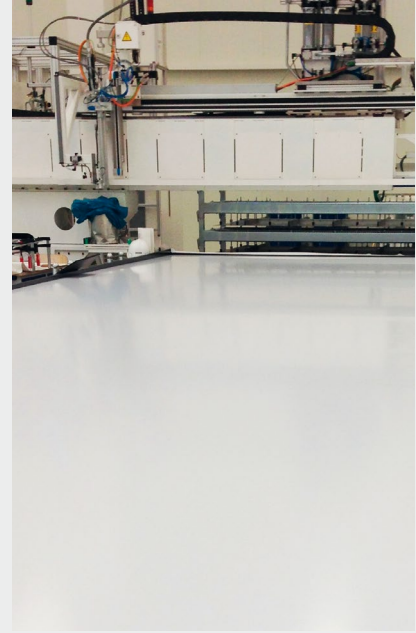

Photos: Application trials at sedak GmbH & Co KG

DEMANDING SPECIAL TESTS

HIGH SPEED TESTS FOR BOMB BLAST AND HURRICANE RESISTANCE

For Sika as one of the market leaders in the automotive and transportation industry high-speed tests are state-of-the-art tests at its high-tech laboratories. Before any crash test or bomb blast test we measure high speed impact on sealants and adhesives on small specimens. Based on these values we help to optimize the joint dimensions.

HIGH SPEED LAP SHEAR TESTS

Test Speed [mm/min]

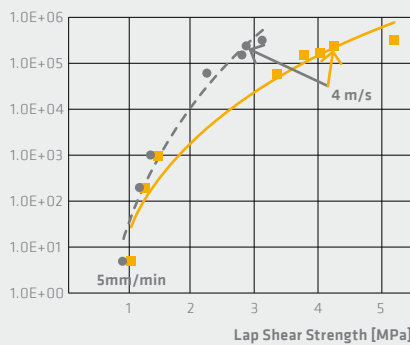
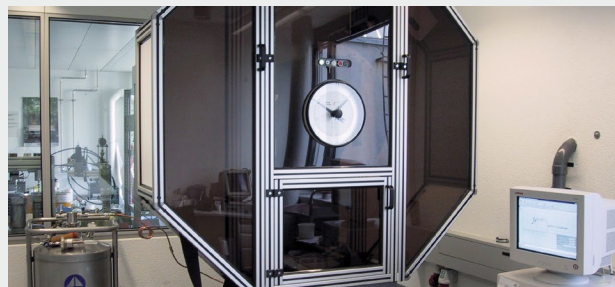

Fig. 31: The higher the impact speed, the higher the adhesives' shear strength, the higher the design stress.



Impact test machine with pendulum (ISO 11343) for velocities of 1 m/s to 5 m/s at temperatures from -50 to 80 °C (-58 - 176 °F). As glass deforms with a max. speed of 4 m/s, this is the optimal range for simulating bomb blast tests.

PRODUCT OVERVIEW

Sikasil® SG

	Sikasil® SG-20	Sikasil® SG-20 S	Sikasil® SG-500
Components	one-component	one-component	two-component
Curing System	neutral	neutral	neutral
Application	by pump or with guns	with guns from foil packs	machine mixing or from dual-cartridges
Permanently elastic range [°C / °F]	-40 - 150 / -40 - 300	-40 - 150 / -40 - 300	-40 - 150 / -40 - 300
Design Values for Calculations			
Max. stress in dynamic tension $\sigma_{dyn}^{1)}$	ETAG [N/mm ²] ASTM [N/mm ² /psi] 0.17 0.138 / 20	- 0.138 / 20	0.14 0.138 / 20
Max. stress in dynamic shear for supported constructions τ_{des} [N/mm ²] (ETAG) ¹⁾	0.12	-	0.105
Max. stress in permanent shear for unsupported constructions $\tau_{\infty}^{1)}$	ETAG [N/mm ²] ASTM [N/mm ² /psi] 0.012 0.007 / 1	- 0.007 / 1	0.0105 0.007 / 1
Markets and relevant Approvals and Certificates			
Markets	EU, NAM	APAC, ME, LAM	EU
Approvals Europe	EOTA ETAG 002 (CE) ²⁾ SNJF-VEC EN 15434		EOTA ETAG 002 (CE) SNJF-VEC EN 15434
Approvals non-EU areas	ASTM C 1184 ASTM C920 S, NS, class 25, Use G, A	ASTM C 1184 ASTM C920 S, NS, class 25, Use G, A GB 16776	ASTM C 1184 ASTM C920 M, NS, class 12.5, Use G, A

¹⁾ EOTA ETAG 002 (2012)

²⁾ Product produced in NAM is not CE marked

These figures are intended as a guide and should not be used in preparing specifications.

Sikasil® SG-500 CN**Sikasil® SG-500 S****Sikasil® SG-550**

two-component

two-component

two-component

neutral

neutral

neutral

machine mixing or
from dual-cartridges

machine mixing

machine mixing

-40 - 150 / -40 - 300

-40 - 150 / -40 - 300

-40 - 150 / -40 - 300

-
0.138 / 20-
0.138 / 200.20
0.20 / 30

-

-

0.13

-
0.007 / 1-
0.007 / 10.013
0.007 / 1

APAC, ME, LAM, NAM

APAC, ME, LAM

Global

ASTM C 1184
ASTM C920 M, NS, class 25,
Use G, AASTM C 1184
ASTM C920 M, NS, class 25,
Use G, A
GB 16776ASTM C1184
ASTM C920 M, NS, class 12.5,
Use G, A

Detailed product information can be found in the corresponding product data sheets.

Adhesive parameters for design and calculation are available in *Sika Additional Product Information - Design parameters for Sikasil® SG adhesives in Facade applications*, to be read in conjunction with *Sika General Guideline - Design and calculation of Sikasil® SG joints in Structural Sealant Glazing applications*. Please ask for the latest respective documentation.

Dollar Bay, London, 2017

Architects SimpsonHaugh; Facade and balustrades Focchi Spa (IT)

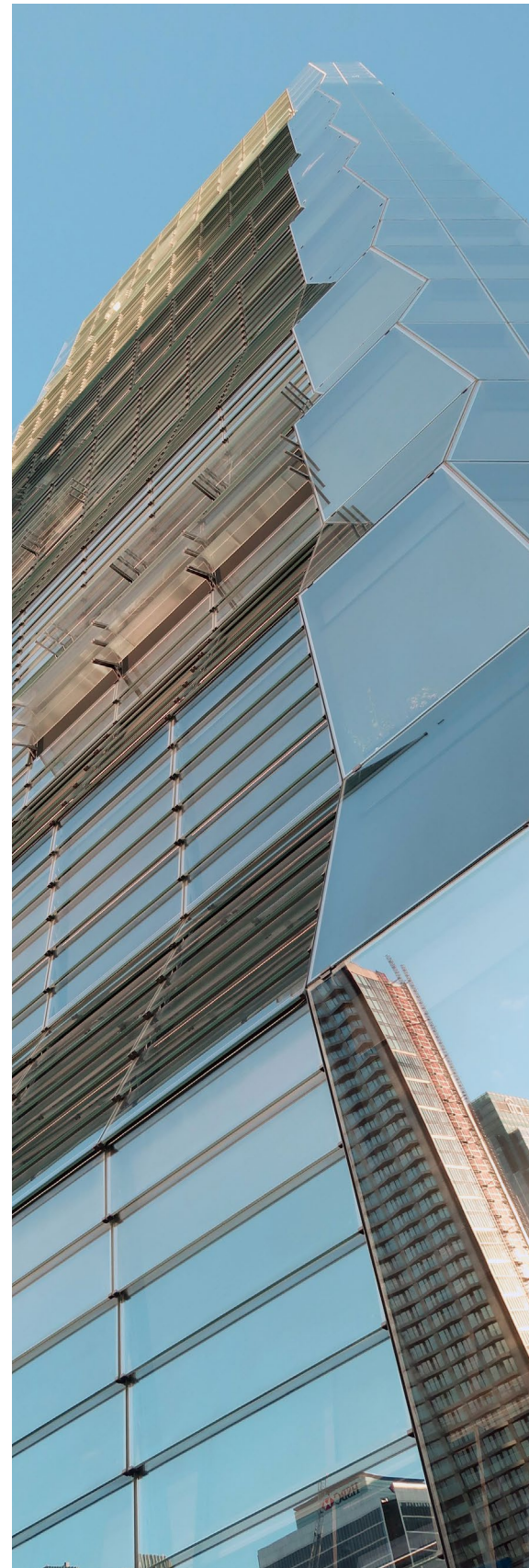

PRODUCT OVERVIEW

Sikasil® IG

	Sikasil® IG-16	Sikasil® IG-25	Sikasil® IG-25 HM Plus
Components	one-component	two-component	two-component
Curing System	neutral	neutral	neutral
Application	with guns from cartridges or foil packs or with pumps	machine mixing	machine mixing
<ul style="list-style-type: none"> - Standard IG for windows and capped CW systems - Symmetrical IG for SG - Stepped IG for SG - IG in two-sided SG - IG for bolted curtain walls - Gas-filled IGU 	<ul style="list-style-type: none"> ■ ■ 	<ul style="list-style-type: none"> ■ ■ ■ ■ ■ 	<ul style="list-style-type: none"> ■ ■ ■ ■ ■ ■
Permanently elastic range [°C / °F]	-40 - 150 / -40 - 300	-40 - 150 / -40 - 300	-40 - 150 / -40 - 300
Design Values for Calculations			
Max. stress in dynamic tension $\sigma_{dyn}^{1)}$	ETAG [N/mm ²] ASTM [N/mm ² /psi]	-	0.138 0.138 / 20
Max. stress in dynamic shear for supported construction τ_{des} [MPa] (ETAG) ¹⁾		-	0.105 .013
Max. stress in permanent shear for unsupported construction $\tau_{\infty}^{1)}$	ETAG [N/mm ²] ASTM [N/mm ² /psi]	-	0.0105 0.007 / 1
Markets and relevant Approvals and Certificates			
Markets	EU	Global	Global
Approvals Europe	EN 1279-4	EN 1279-2, -4 EOTA ETAG 002 (CE) ²⁾ CEKAL, SNJF VI-VEC	EN 1279-2, -3, -4 EOTA ETAG 002 (CE) ²⁾ EN 15434 CEKAL, RAL GZ-520
Approvals non-EU areas		ASTM C1184 ASTM C1369 GB 16776	ASTM C1184 ASTM C1369

¹⁾ EOTA ETAG 002 (2012)

²⁾ Product produced in NAM is not CE marked

These figures are intended as a guide and should not be used in preparing specifications.
For technical information about the products, please ask for the latest respective data sheets.

Sikasil® IG-25 S

two-component

neutral

machine mixing



-40 - 150 / -40 - 300

-
0.138 / 20

-
0.007 / 1

APAC, ME, LAM

ASTM C1184
ASTM C1369
GB 16776

One Blackfriars, London, 2019
Architects SimpsonHaugh; Facade and balustrades Shenyang Yuanda (CN)



PRODUCT OVERVIEW

Sikasil® WS

	Sikasil® WS-305 EU	Sikasil® WS-305 S	Sikasil® WS-300 S	Sikasil® WS-305 AM
Components	one-component	one-component	one-component	one-component
Curing System	neutral	neutral	neutral	neutral
Special features			translucent	
Application	with guns from cartridges or foil packs or with pumps	with guns from foil packs	with guns from cartridges or foil packs	with guns from cartridges or foil packs or with pumps
Permanently elastic range	[°C] -40 - 150 [°F] -40 - 300	-40 - 150 -340	-40 - 150 -40 - 300	-40 - 150 -40 - 300
Movement capability c ¹⁾ [%]	± 50	± 50	± 25	± 50
Markets and relevant Approvals and Certificates				
Markets	EU	APAC, ME, LAM	APAC, ME, LAM	NAM
Approvals Europe	ISO 11600 F&G 25LM EN 15651-1 F EXT-INT CC 25 LM (CE-marked) EN 15651-2 G CC 25 LM (CE-marked)			
Approvals non-EU areas	ASTM C-920, S, NS, Class 50, NT, M, G, A	ASTM C-920, S, NS, Class 50, G, A GB/T 14683	ASTM C-920, S, NS, Class 25, G, A	ASTM C-920, S, NS, Class 50, NT, M, G, A

¹⁾ ISO 11600 or ASTM C719

These figures are intended as a guide and should not be used in preparing specifications.
For technical information about the products, please ask for the latest respective data sheets.

Sikasil® WS-200	Sikasil® WS-605 S	Sikasil® WS-355 N	Sikasil® WS-290	Sikasil® WS-295	Sikasil® WS-300 EU
one-component	one-component	one-component	one-component	one-component	one-component
neutral	neutral	neutral	neutral	neutral	neutral
translucent	non-streaking, non-staining	non-streaking, non-staining	Ultra-low modulus, non-staining	Medium modulus	
with guns from cartridges or foil packs	with guns from cartridges or foil packs or with pumps	with guns from foil packs	with guns from cartridges or foil packs or with pumps	with guns from cartridges or foil packs or with pumps	with guns from cartridges or foil packs
-40 - 150 -40 - 300	-40 - 150 -40 - 300	-40 - 150 -40 - 300	-40 - 150 -430	-40 - 150 -430	-40 - 150 -40 - 300
± 25	± 50	± 50	± 100 / -50	± 50	± 25
EU	Global	APAC, ME, LAM	NAM	NAM	EU
ISO 11600 F&G 25LM EN 15651-1 F EXT-INT 25LM (CE-marked) EN 15651-2 G CC 25LM (CE-marked) AENOR Marca N F+G 25LM SNJF Facade & Vitrage 25 E	ISO 11600 F&G 25LM EN 15651-1 F EXT-INT 25LM (CE-marked) EN 15651-2 G CC 25LM (CE-marked) AENOR Marca N F+G 25LM SNJF Facade & Vitrage 25 E				ISO 11600 F&G 25LM EN 15651-1 F EXT-INT 25LM (CE-marked) EN 15651-2 G CC 25LM (CE-marked)
ASTM C-920, S, NS, Class 25, NT, G, A	ASTM C-920, S, NS, Class 35, G, M, A ASTM C 1248	ASTM C-920, S, NS, Class 50, NT, G, A ASTM C 1248	ASTM C 920, S, NS, Class 100/50, NT, M, G, A, OTT- S-00230C, Type II, Class A TT-S-001543A, Class A ASTM C 1248 CAN/CGSB- 19.13-M87 AAMA 808.3	ASTM C 920, S, NS, Class 50, NT, M, G, A, O TT-S-00230C, Type II, Class A CAN/CGSB-19.13-M87 AAMA 802.3 Type II AAMA 803.3 AAMA 805.2 AAMA 808.3	ASTM C-920, S, NS, Class 25, NT, G, A

COLOR GUIDE

Transparent White Beige Bronze Black

Grey S3 Grey S6 Grey S1 Grey S4

For locally available colors and for color cards with silicone swatches ask your Sika sales representative.

Sikasil® ENGINEERING SILICONES PACKAGING UNITS

Sikasil®	SG-15	SG-20	SG-20 S	SG-500	SG-500 CN	SG-500 S	SG-550	IG-16	IG-25	IG-25 HM Plus
Cartridge	■	■								
Foil pack	■	■	■					■		
Pail		■						■		
Drum		■						■		
Kit (drum+pail)				■	■	■	■		■	■
Dual cartridge				■	■					

Sikasil®	WS-305 EU	WS-305 S	WS-300 S	WS-305 AM	WS-200	WS-605 S	WS-355 N	WS-290	WS-395	WS-300 EU
Cartridge	■		■	■	■	■		■	■	■
Foil pack	■	■	■	■	■	■	■	■	■	■
Pail				■		■		■	■	
Drum				■		■				

Sikasil® PRETREATMENT AGENTS PACKAGING UNITS

Sikasil®	Sika® Cleaner G+M	Sika® Cleaner P	Sika® Aktivator-205	Sika® Primer-210	Sika® Primer-790	Sika® Mixer Cleaner
0.25-liter bottle				■		
1-liter bottle	■	■	■	■	■	
5-liter can	■	■	■			
25-liter pail						■
200-liter drum						■

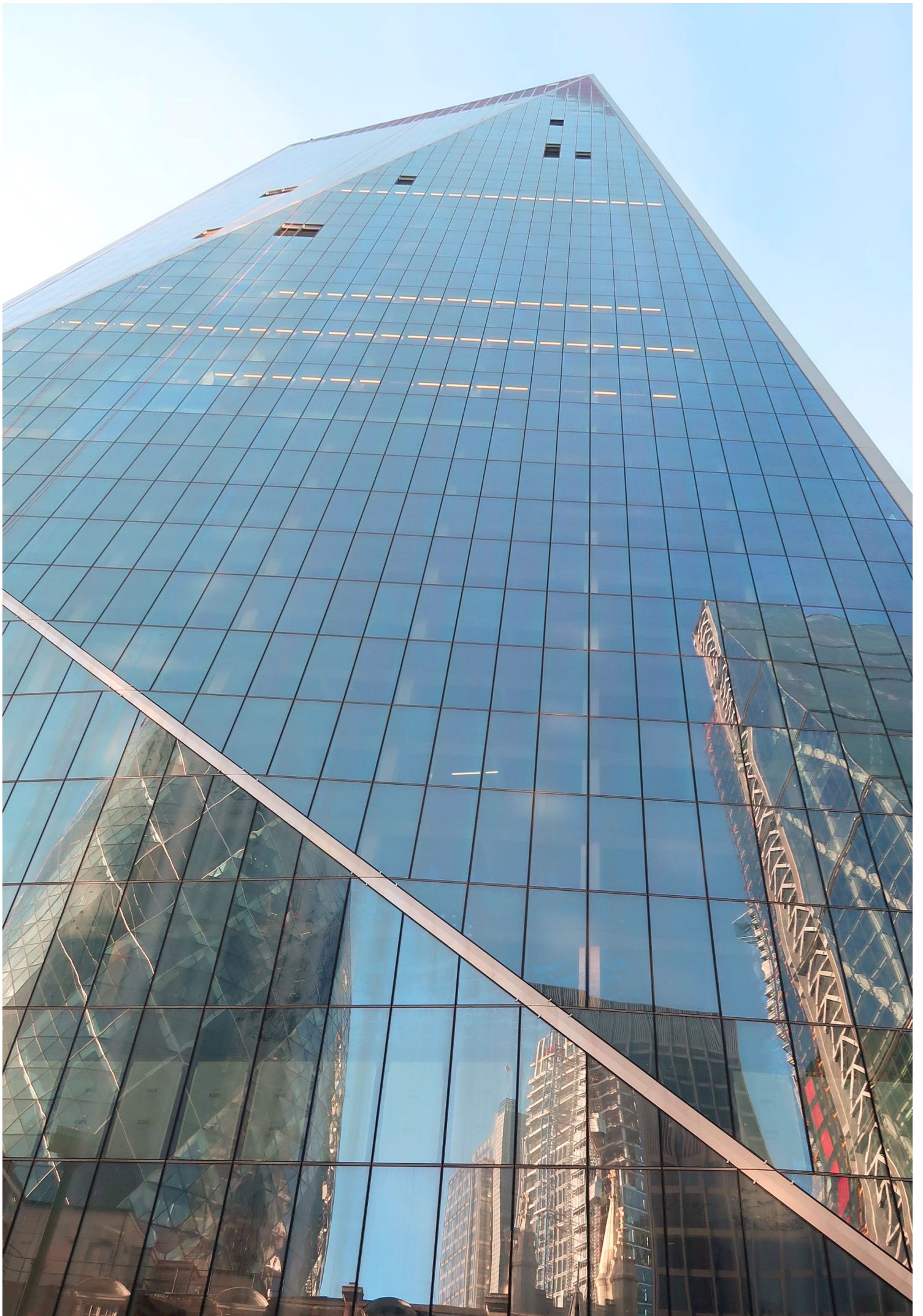

GLOBAL BUT LOCAL PARTNERSHIP

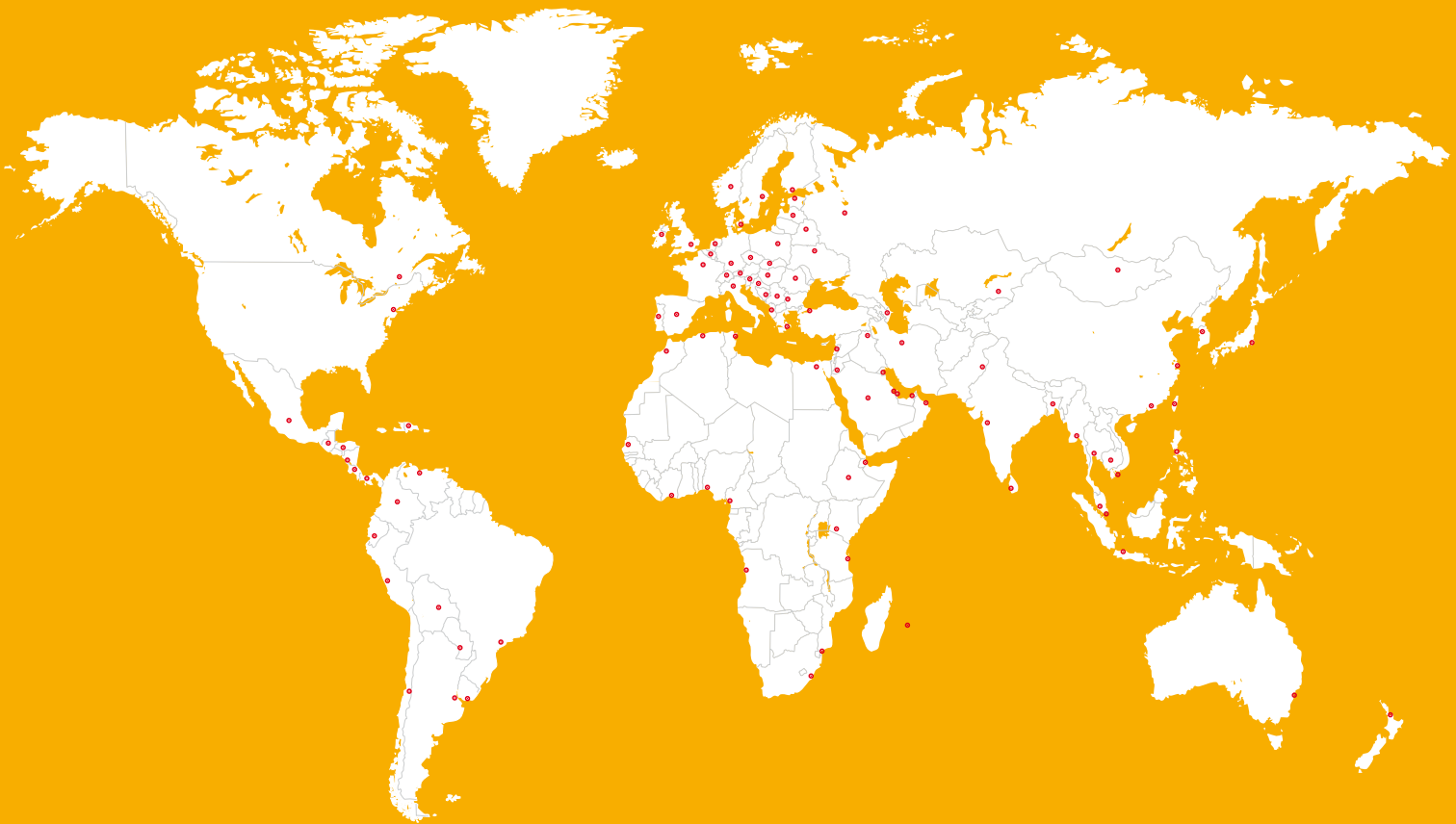

CONTACT US FOR MORE INFORMATION



www.sika.com/facade

Sika AG, Switzerland, is a globally active specialty chemicals company. Sika supplies the building and construction industry as well as manufacturing industries (automotive, bus, truck, rail, solar and wind power plants, facades). Sika is a leader in processing materials used in sealing, bonding, damping, reinforcing and protecting loadbearing structures. Sika's product lines feature high quality concrete admixtures, specialty mortars, sealants and adhesives, damping and reinforcing materials, structural strengthening systems, industrial flooring as well as roofing and waterproofing systems.



Our most current General Sales Conditions shall apply. Please consult the most current local Product Data Sheet prior to any use.



SIKA SERVICES AG
Tueffenwies 16
CH-8048 Zurich
Switzerland

Contact
Phone +41 58 436 40 40
Fax +41 58 436 55 30
www.sika.com/facade

BUILDING TRUST

